

Rituel

par Pur Béton

CuV 96

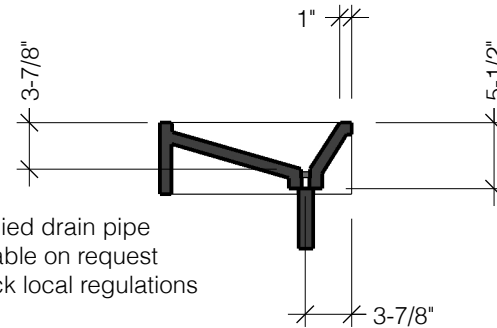
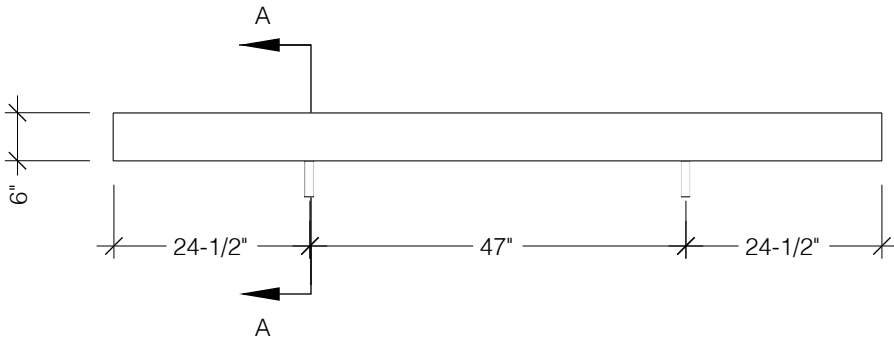
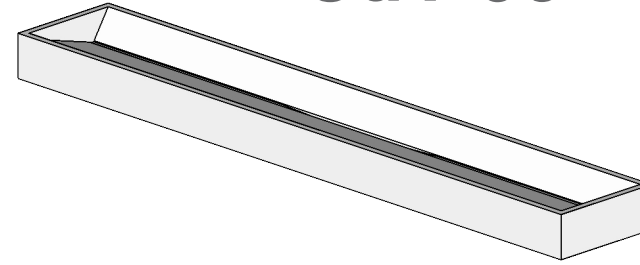

1.1/4" supplied drain pipe
 1.1/2" available on request
 Please check local regulations

Section A-A
 not to scale

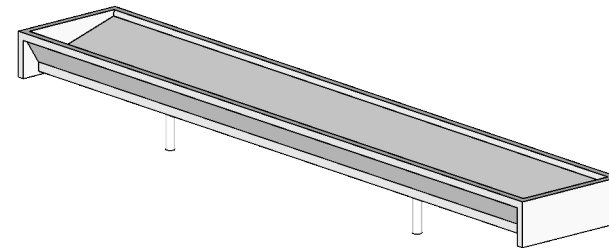
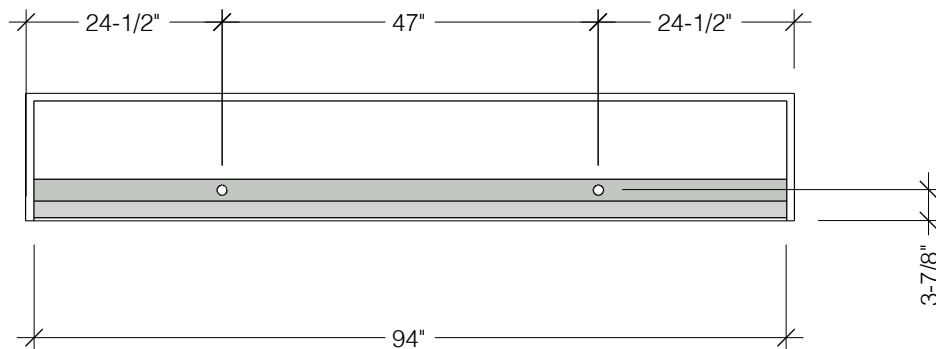

General notes

Pur Béton work to tolerances of +/- 1/8" on all dimensions. It is the responsibility of the client to verify that all dimensions and said tolerances are suitable for the purpose of the project.

Tap holes for surface mounted taps.

Pur Béton work to tolerances of +/- 1/4" on all positioning and hole diameters of taps holes.

It is the client responsibility to specify the proper hole patterns and positioning necessary for proper fit of taps.

A supplemental drawing will then be issued by Pur Béton and a signature will be asked to confirm positioning of hole pattern prior to manufacturing.

Product description:

Concrete bathroom sink

Suitable for wall or surface mounting.
 Design for use with wall mounted tap or from counter top taps.
 Available with or without brackets.

Supplied with 2 x 5" long, 1.1/4" dia. chrome drain pipe.
 1.1/2" available on request
 Please check local regulations

Length: 96"
 Width: 16"
 Height: 6"
 Weight: 225 lbs

CuV 96



178 Rang Duncan
 St-Chrysostome (Québec)
 Canada J0S 1R0
514 886-2444
 info@purbeton.com
purbeton.com