

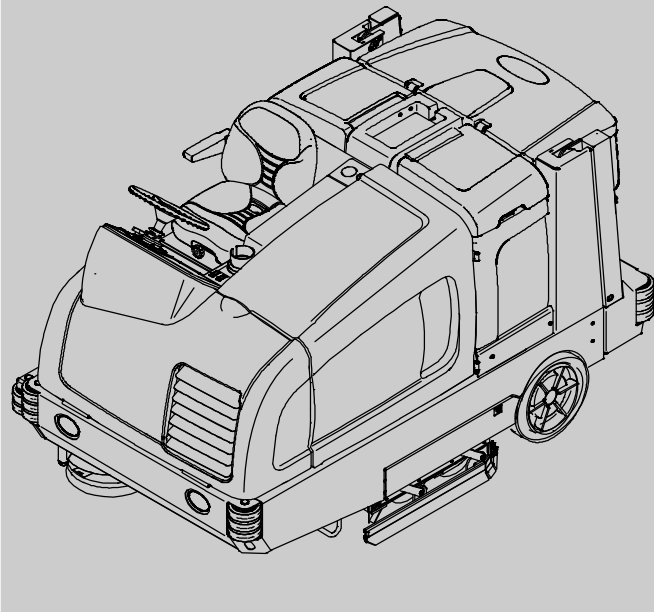

M30

(Gas/LPG)



(SN/ 008000-)
Scrubber-Sweeper
English **EN**
Operator Manual



The Safe Scrubbing Alternative[®]

ES[®] Extended Scrub System

TennantTrue[®] Parts

Hygenic[®] Fully Cleanable Tanks

FloorSmart[®] Integrated Cleaning System

IRIS[®] a Tennant Technology

Pro-Panel[™] Controls

Insta-Fit[™] Adapter



An ORBIO[™] Technology

North America / International



For the latest Parts manuals and other
language Operator manuals, visit:

www.tennantco.com/manuals

9016100
Rev. 03 (2-2020)



INTRODUCTION

This manual is furnished with each new model. It provides necessary operation and maintenance instructions.



Read this manual completely and understand the machine before operating or servicing it.

This machine will provide excellent service. However, the best results will be obtained at minimum costs if:

- The machine is operated with reasonable care.
- The machine is maintained regularly - per the machine maintenance instructions provided.
- The machine is maintained with manufacturer supplied or equivalent parts.

PROTECT THE ENVIRONMENT	MACHINE DATA
	Please fill out at time of installation for future reference.
Please dispose of packaging materials, used components such as batteries and fluids in an environmentally safe way according to local waste disposal regulations.	Model No. – _____
	Serial No. – _____
Always remember to recycle.	Installation Date – _____

INTENDED USE

The M30 is an industrial rider machine designed to sweep/scrub hard surfaces (concrete, asphalt, stone, synthetic, etc). Typical applications include industrial warehouses, manufacturing facilities, distribution facilities, stadiums, arenas, convention centers, parking facilities, transportation terminals, and construction sites. Do not use this machine on soil, grass, artificial turf, or carpeted surfaces. This machine can be used both indoors and outdoors, but ensure there is adequate ventilation if used indoors. This machine is not intended for use on public roadways. Do not use this machine other than described in this Operator Manual.

Tennant Company

PO Box 1452

Minneapolis, MN 55440

Phone: (800) 553-8033

www.tennantco.com



CALIFORNIA PROPOSITION 65 WARNING:

Engine exhaust from this product contains chemicals known to the State of California to cause cancer, birth defects, or other reproductive harm.

PerformanceView, Pro-ID, Pro-Check, Zone Settings, Thermo-Sentry, Touch-N-Go, 1-STEP, Clean-Wedge, Variable Drain Valve, EasyOpen, Grip-n-Go, MaxPro, Dura-Track, SmartRelease, InstantAccess, Duramer, FaST-PAK, ErgoSpace, and Lower Total Cost of Ownership are trademarks of Tennant Company.

Specifications and parts are subject to change without notice.

Original Instructions, copyright © 2016, 2017, 2019. 2020 TENNANT Company, Printed in U.S.A.

CONTENTS

	Page		Page
Important Safety Instructions – Save These Instructions	3	How The Machine Works	31
Operation	7	Brush Information	32
Machine Components	7	While Operating The Machine	32
Controls And Instruments	8	Pre-Operation Checklist	33
Standard Touch Panel	9	Changing The Lpg Tank	34
Pro-Panel Controls	10	Starting The Machine	35
Symbol Definitions	11	Turning Off The Machine	35
Operation Of Controls – Standard Panel ..	14	Filling The Solution Tank	36
Fuel Indicator	14	Foam Scrubbing (Fast Mode) /	
Gasoline Machines	14	Ec-H2o Scrubbing (Ec-H2o Mode) ..	36
Lpg Machines	14	Conventional Scrubbing Mode	36
Hour Meter	14	Es (Extended Scrub) Mode With	
Recovery Tank Full Indicator	14	Auto-Fill	37
Solution Tank Indicator	14	Es (Extended Scrub) Mode –	
Contrast Control Button	15	Manually Filling Tanks	37
Engine Speed Button	15	Setting Scrub Modes	38
1-Step Button	15	Setting Ec-H2o Mode	38
Sweeping Side Brush Button (Option) ..	15	Setting Fast Mode	39
Sweeping Vacuum Fan Button	16	Setting Es (Extended Scrub) Mode	39
Sweeping Main Brush Button	16	Setting Brush Pressure	40
Scrubbing Side Brush Button (Option) ..	16	Setting Brush Pressure –	
Scrubbing Vacuum Fan /		Standard Panel	40
Squeegee Button	16	Setting Brush Pressure – Pro-Panel ..	40
Scrubbing Main Brush Button	17	Setting Solution Flow	41
Solution On / Off Button	17	Es (Extended Scrub) Solution Flow ...	41
Operation Of Controls – Pro-Panel	17	Setting Solution Flow – Standard Panel	41
Pro-Id Login Screen	17	Setting Solution Flow – Pro-Panel	41
Machine Status Button	18	Scrubbing – Standard Panel	42
Changing The Default Button	19	Scrubbing – Pro-Panel	43
1-Step Button	19	Double Scrubbing	44
Sweeping Main Brush Button	20	Water Pickup Mode (No Scrubbing)	45
Sweeping Vacuum Fan Button	20	Sweeping – Standard Panel	46
Sweeping Side Brush Button (Option) ..	20	Sweeping – Pro-Panel	47
Scrubbing Main Brush Button	20	Emptying The Hopper	48
Scrubbing Vacuum Fan /		Engaging Hopper Support Pin	49
Squeegee Button	21	Disengaging Hopper Support Pin	49
Scrubbing Side Brush Button (Option) ..	21	Removing The Hopper Dust Filter	50
Solution On / Off Buttons	21	Cleaning The Hopper And Debris Screen ..	51
Engine Speed Button	22	Draining And Cleaning The Recovery Tank	52
Zone Control Buttons	22	Draining The Recovery Tank With	
Rearview Camera Button	23	The Drain Hose	52
Help Button	24	Draining The Recovery Tank With	
Video Help Button	26	The Drain Plug	53
Completing The Pro-Check		Draining And Cleaning The Solution Tank ..	54
Pre-Operation Checklist	27	Faults / Alerts	56
Operation Of Controls – All Machines	28	Fault / Alert Indicators – Standard Panel	56
Operating Lights	28	Fault / Alert Indicators – Pro-Panel ...	56
Hazard Light (Option)	28	Options	58
Filter Shaker Switch	28	Spray Nozzle (Option)	58
Operator Seat	29	Vacuum Wand (Option)	59
Seat Belts	29	High Pressure Washer (Option)	60
Steering Column Tilt Knob	29	Machine Troubleshooting	62
Brake Pedal	29		
Parking Brake Pedal	29		
Directional Pedal	30		
Squeegee Protectors (Option)	30		

CONTENTS

	Page		Page
Maintenance	64	Leveling The Rear Squeegee	87
Maintenance Chart	65	Adjusting The Rear Squeegee	
Yellow Touch Points	68	Blade Deflection	87
Lubrication	68	Skirts And Seals	88
Engine Oil	68	Scrub Head Skirt	88
Squeegee Caster Bearings	68	Recovery Tank Seal	88
Front Wheel Support Bearing	68	Solution Tank Seals	88
Steering Cylinder Bearing	68	Brakes And Tires	89
Rear Wheel Bearings	69	Brakes	89
Hopper Lift Arm Pivots	69	Tires	89
Hopper Door Pivots	69	Front Wheel	89
Lift Arm Latch	69	Propelling Motor	89
Torque Tubes	69	Pushing, Towing, And Transporting	
Hydraulics	70	The Machine	90
Hydraulic Fluid	70	Pushing Or Towing The Machine	90
Hydraulic Hoses	71	Transporting The Machine	90
Engine	71	Machine Jacking	92
Cooling System	71	Storage Information	92
Air Filter	72	Freeze Protection (Machines Without	
Fuel Filter (Lpg)	72	Ec-H2o System)	93
Fuel Filter (Gasoline)	72	Freeze Protection (Machines With	
Lpg Vaporizer	72	Ec-H2o System)	93
Engine Belt	73	Priming The Ec-H2o System	95
Pcv System	73	Specifications	96
Spark Plugs	73	General Machine Dimensions/Capacities	96
Camshaft And Balance Shaft Belts	73	General Machine Performance	96
Battery	73	Hydraulic System	97
Fuses And Relays	74	Tires	97
Relay Panel Fuses And Relays	74	Steering	97
Engine Harness Fuses And Relays	75	Fast System	98
Optional Relays	75	Ec-H2o System	98
Circuit Breakers (Ec-H2o)	75	Machine Dimensions	99
Cleaning The Hopper Dust Filter	75	Supervisor Controls	100
Thermo-Sentry	76	Pro-Panel Supervisor Controls	100
Main Brushes	76	Entering The Supervisor Mode -	
Replacing Or Rotating The Main		First Time Use Only	100
Brushes	76	Entering The Supervisor Mode	101
Checking The Main Brush Pattern	77	Supervisor Setting Screen / Screen	
Adjusting The Main Brush Taper	78	Icons	102
Adjusting The Main Brush Width	78	Adding / Editing Profiles	103
Side Brush (Option)	79	Enabling The Login	105
Replacing The Side Brush	79	Disabling The Login	106
Fast System	80	Calibrating The Touch	106
Replacing The Fast-Pak Carton	80	Exporting Checklists	107
Cleaning The Fast Supply Hose		Checklist Setup	108
Connector	80	Disabling / Enabling The Pre-	
Cleaning The Fast System Filter Screen	80	Operation Checklist	109
Replacing The Fast System Filters	81	Changing The Rear View Camera	
Ec-H2o Module Flush Procedure	81	Settings	110
Cleaning The Ec-H2o Filter Screen	82	Programming The Zone Control	
Squeegee Blades	83	Buttons	110
Replacing (Or Rotating) The Rear		Setting / Changing The Date And Time	112
Squeegee Blades	83	Index	113
Replacing Or Rotating The Side			
Squeegee Blades	84		
Replacing Or Adjusting The Side			
Brush Squeegee Blade (Option)	86		

IMPORTANT SAFETY INSTRUCTIONS – SAVE THESE INSTRUCTIONS

The following precautions are used throughout this manual as indicated in their description:

 **WARNING:** To warn of hazards or unsafe practices that could result in severe personal injury or death.

 **CAUTION:** To warn of unsafe practices that could result in minor or moderate personal injury.

FOR SAFETY: To identify actions that must be followed for safe operation of equipment.

The following information signals potentially dangerous conditions to the operator. Know when these conditions can exist. Locate all safety devices on the machine. Report machine damage or faulty operation immediately.

 **WARNING:** Flammable materials can cause an explosion or fire. Do not use flammable materials in tank.

 **WARNING:** Flammable materials or reactive metals can cause an explosion or fire. Do not pickup.

 **WARNING:** Moving belt and fan. Keep away.

 **WARNING:** Engine emits toxic gases. Serious injury or death can result. Provide adequate ventilation.

 **WARNING:** Raised hopper may fall. Engage hopper support pin.

 **WARNING:** Lift arm pinch point. Stay clear of hopper lift arms.

 **WARNING:** Burn hazard. Hot surface. Do NOT touch.

 **WARNING:** Do not spray people or animals. Severe personal injury can result. Wear eye protection. Hold sprayer with two hands.

 **CAUTION:** LPG engine will run for a few seconds after key is turned off. Apply parking brake before leaving machine.

This machine may be equipped with technology that automatically communicates over the cellular network. If this machine will be operated where cell phone use is restricted because of concerns related to equipment interference, please contact a Tennant representative for information on how to disable the cellular communication functionality.

FOR SAFETY:

1. Do not operate machine:
 - Unless trained and authorized.
 - Unless operator manual is read and understood.
 - Under the influence of alcohol or drugs.
 - While using a cell phone or other types of electronic devices.
 - In dusty environments without the vacuum fan on.
 - Without filters in place or with clogged filters.
 - Unless mentally and physically capable of following machine instructions.
 - If it is not in proper operating condition.
 - With pads or accessories not supplied or approved by Tennant. The use of other pads may impair safety.
 - In areas where flammable vapors/liquids or combustible dusts are present.
 - In areas that are too dark to safely see the controls or operate the machine unless operating / headlights are turned on.
 - In areas with possible falling objects unless equipped with overhead guard.
2. Before starting machine:
 - Check for fuel, oil, and liquid leaks.
 - Keep sparks and open flame away from refueling area.
 - Make sure all safety devices are in place and operate properly.
 - Check brakes and steering for proper operation.
 - Adjust seat and fasten seat belt.
3. When starting machine:
 - Keep foot on brake and directional pedal in neutral.

SAFETY PRECAUTIONS

4. When using machine:

- Use only as described in this manual.
- Use brakes to stop machine.
- Do not pick up burning or smoking debris, such as cigarettes, matches or hot ashes
- Go slowly on inclines and slippery surfaces.
- Do not scrub on ramp inclines that exceed 10% grade or transport (GVWR) on ramp inclines that exceed 14% grade.
- Reduce speed when turning.
- Keep all parts of body inside operator station while machine is moving.
- Always be aware of surroundings while operating machine.
- Do not access the video / help screens while the machine is moving. (Pro-Panel).
- Use care when reversing machine.
- Move machine with care when hopper is raised.
- Make sure adequate clearance is available before raising hopper.
- Do not raise hopper when machine is on an incline.
- Keep children and unauthorized persons away from machine.
- Do not carry passengers on any part of the machine.
- Always follow safety and traffic rules.
- Report machine damage or faulty operation immediately.
- Follow mixing, handling and disposal instructions on chemical containers.
- Follow site safety guidelines concerning wet floors.

5. Before leaving or servicing machine:

- Do not park near combustible materials, dusts, gases, or liquids.
- Stop on level surface.
- Set parking brake.
- Turn off machine and remove key.

6. When servicing machine:

- All work must be done with sufficient lighting and visibility.
- Avoid moving parts. Do not wear loose clothing, jewelry and secure long hair.
- Block machine tires before jacking machine up.
- Jack machine up at designated locations only. Support machine with jack stands.
- Use hoist or jack that will support the weight of the machine.
- Do not power spray or hose off machine near electrical components.

- Disconnect battery connections before working on machine.
- Avoid contact with battery acid.
- Avoid contact with hot engine coolant.
- Do not remove cap from radiator when engine is hot.
- Allow engine to cool.
- Keep flames and sparks away from fuel system service area. Keep area well ventilated.
- Use cardboard to locate leaking hydraulic fluid under pressure.
- All repairs must be performed by a trained service mechanic.
- Do not modify the machine from its original design.
- Use Tennant supplied or approved replacement parts.
- Wear personal protective equipment as needed and where recommended in this manual.



For Safety: wear hearing protection.



For Safety: wear protective gloves.



For Safety: wear eye protection.



For Safety: wear protective dust mask.

7. When loading/unloading machine onto/off truck or trailer:

- Use ramp, truck or trailer that will support the weight of the machine and operator.
- Drain tanks before loading machine.
- Empty debris hopper before loading machine.
- Lower scrub head and squeegee before tying down machine.
- Turn off machine and remove key.
- Do not load/unload on ramp inclines that exceed 10 deg/18% grade.
- Set parking brake after machine is loaded.
- Block machine tires.
- Tie machine down to truck or trailer.

The following safety labels are mounted on the machine in the locations indicated. If these or any labels become damaged or illegible, install a new label in its place.

WARNING LABEL – Machine emits toxic gases. Serious injury or death can result. Provide adequate ventilation.

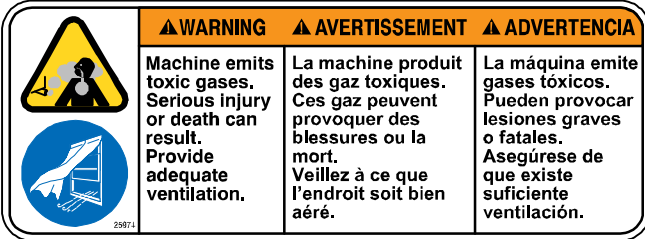

Located on the side of the operator compartment.

FOR SAFETY LABEL – Read manual before operating machine

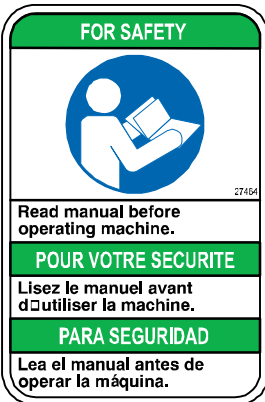

Located on the side of the operator compartment.

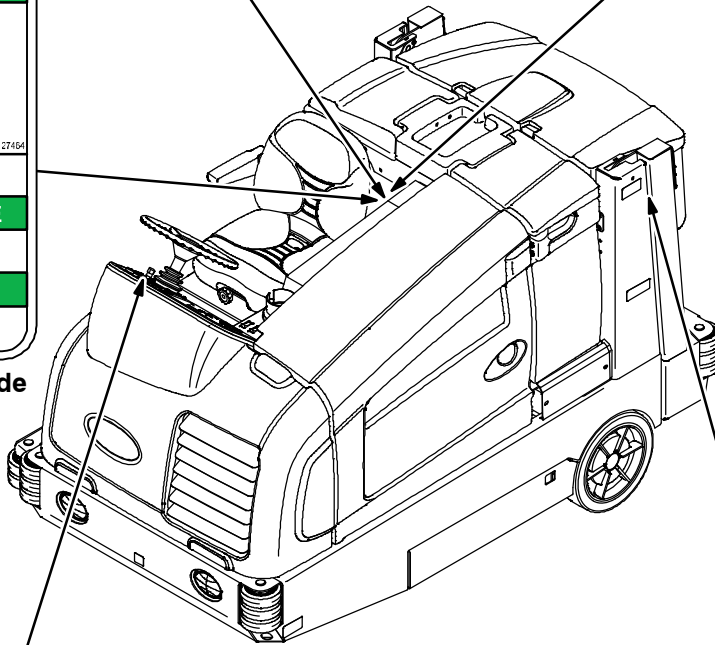

WARNING LABEL – Flammable materials or reactive metals can cause explosion or fire. Do not pick up.



Located on the side of the operator compartment.

CAUTION LABEL – LPG engine will run for a few seconds after key is turned off. Apply parking brake before leaving machine.

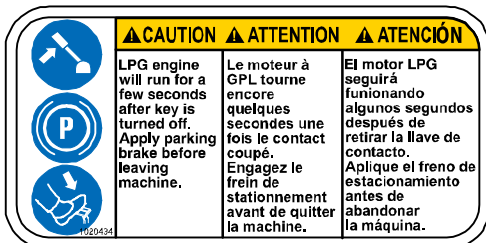

Located next to the ignition switch on the instrument panel. (LPG machines only)

WARNING LABEL – Lift arm pinch point. Stay clear of hopper lift arms

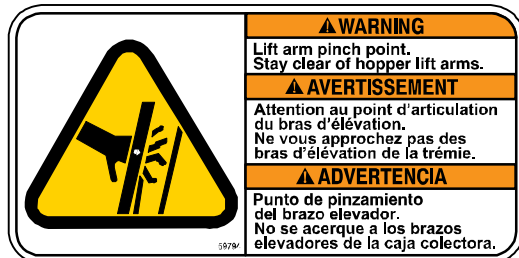

Located on both hopper lift arms.

SAFETY PRECAUTIONS

WARNING LABEL –
Do not spray people or animals. Severe personal injury can result. Wear eye protection. Hold sprayer with both hands.

▲ WARNING
<p>Do not spray people or animals. Severe personal injury can result. Wear eye protection. Hold sprayer with two hands.</p>
▲ AVERTISSEMENT
<p>N'aspérez pas les personnes ou les animaux. Vous pourriez occasionner de graves blessures. Portez une protection oculaire. Tenez le pulvérisateur à deux mains.</p>
▲ ADVERTENCIA
<p>No pulverizar sobre personas o animales. Pueden producirse lesiones graves. Utilice protección ocular. Sujete el pulverizador con ambas manos.</p>

Located on frame of machine.

WARNING LABEL – Burn hazard. Hot surface. Do NOT touch

	▲ WARNING
	<p>Burn hazard. Hot surface. Do NOT touch.</p>
	▲ AVERTISSEMENT
<p>Risque de brûlures. Surface chaude. Ne pas toucher.</p>	
▲ ADVERTENCIA	
<p>Peligro de quemaduras. Superficie caliente. NO tocar.</p>	

Located on the side of the bumper, on the exhaust shield, and on the hydraulic reservoir.

WARNING LABEL –
Moving belt and fan. Keep away.

▲ WARNING
<p>Moving belt and fan. Keep away.</p>
▲ AVERTISSEMENT
<p>La courroie et le ventilateur sont en mouvement. Ne vous approchez pas.</p>
▲ ADVERTENCIA
<p>Correa y ventilador en movimiento. Manténgase alejado.</p>

Located on engine compartment panel.

WARNING LABEL – Flammable materials can cause explosion or fire. Do not use flammable materials in tank.

	▲ WARNING	▲ AVERTISSEMENT	▲ ADVERTENCIA
	<p>Flammable materials can cause explosion or fire. Do not use flammable materials in tank.</p>	<p>Les matières inflammables peuvent causer une explosion ou un incendie. N'utilisez pas de matières inflammables dans le(s) réservoir(s).</p>	<p>Los materiales inflamables pueden provocar explosiones o incendios. No utilice materiales inflamables en el depósito(s).</p>

Located next to the solution tank covers and on the detergent tank.

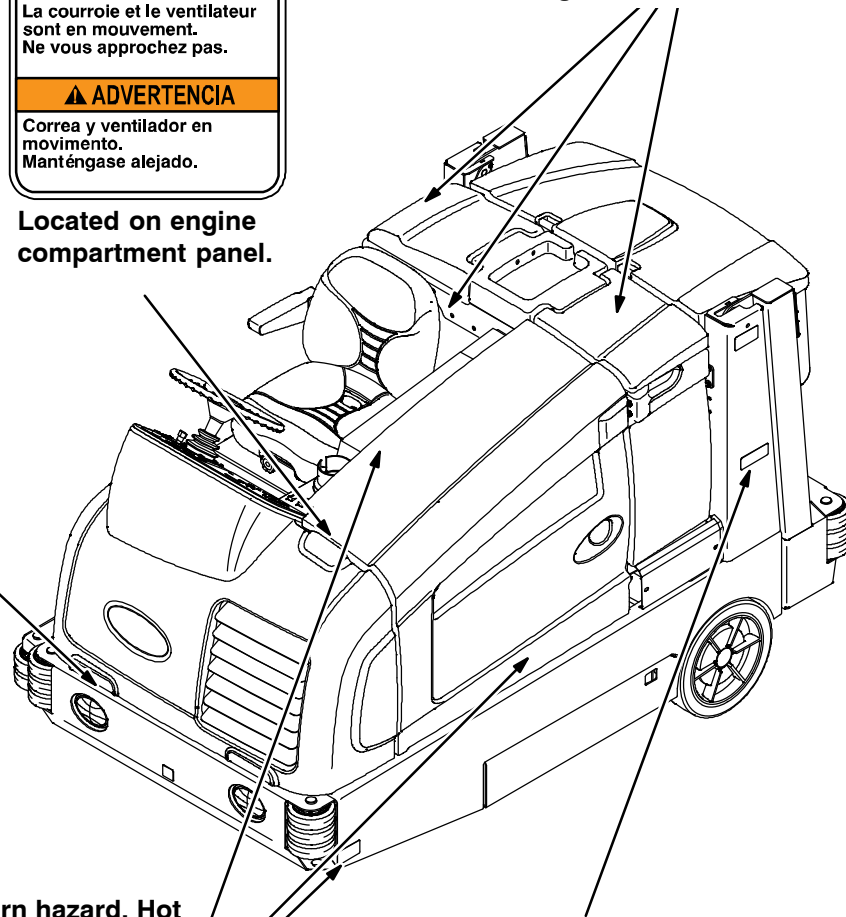

WARNING LABEL – Raised hopper may fall. Engage hopper support pin.

	▲ WARNING	▲ AVERTISSEMENT	▲ ADVERTENCIA
	<p>Raised hopper may fall. Engage hopper support pin.</p>	<p>En position relevée, le bac à déchets peut retomber. Engagez la broche du support de bac à déchets.</p>	<p>La caja colectora elevado puede caer. Coloque el pasador de apoyo de la caja colectora.</p>

Located on both hopper lift arms.

OPERATION

MACHINE COMPONENTS

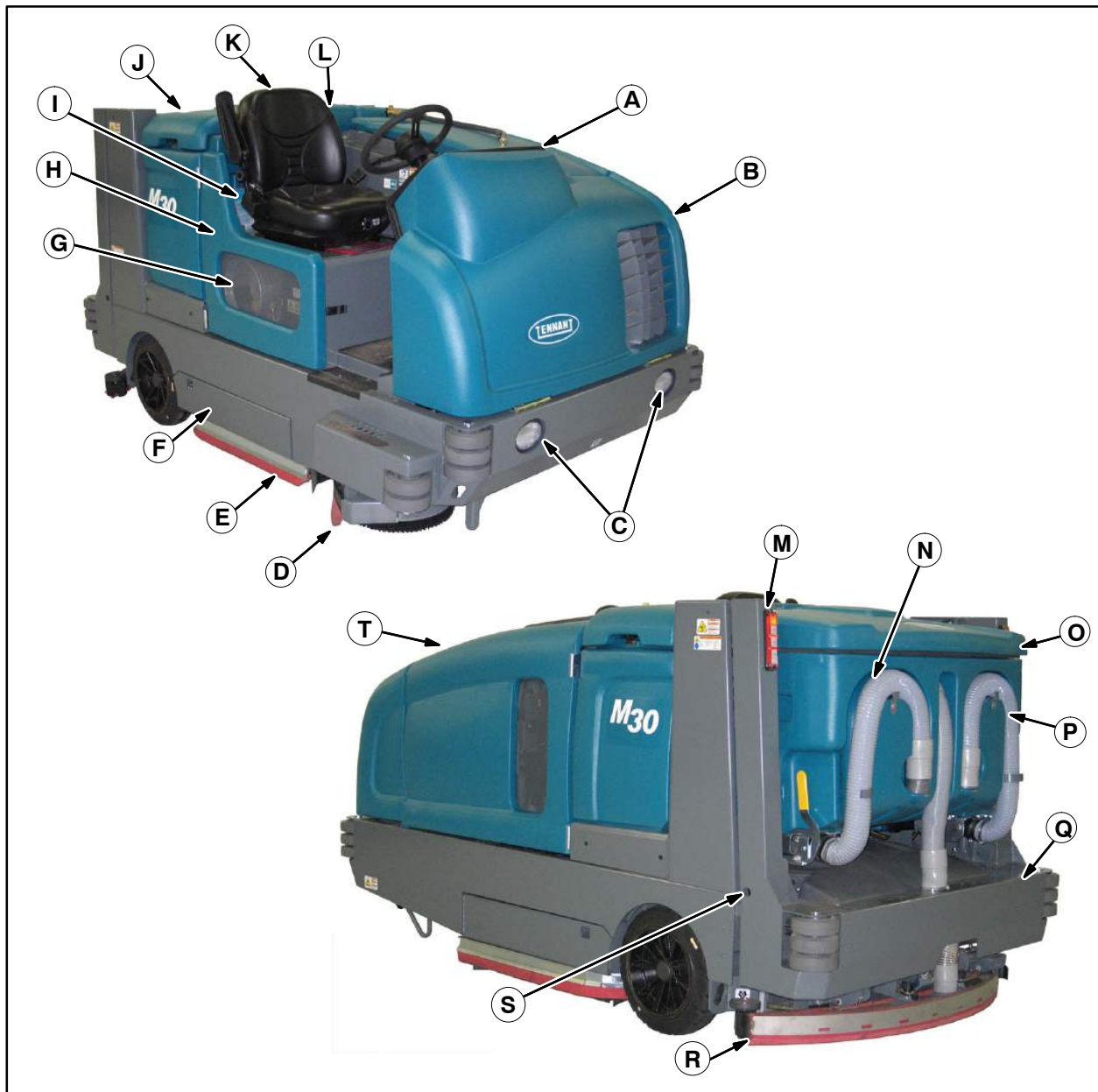

- A. Instrument panel
- B. Front shroud
- C. Headlights
- D. Side brush (option)
- E. Side squeegee
- F. Scrub head access door
- G. Fuel tank
- H. Seat shroud
- I. FaST carton, or ES detergent tank, or ec-H₂O System Module compartment (option)
- J. Solution tank cover

- K. Operator seat
- L. Spray wand – nozzle behind seat (option)
- M. Taillights
- N. Recovery tank drain hose
- O. Recovery tank cover
- P. Solution tank drain hose
- Q. Hopper
- R. Rear squeegee
- S. Hopper safety pin
- T. Engine cover

OPERATION

CONTROLS AND INSTRUMENTS

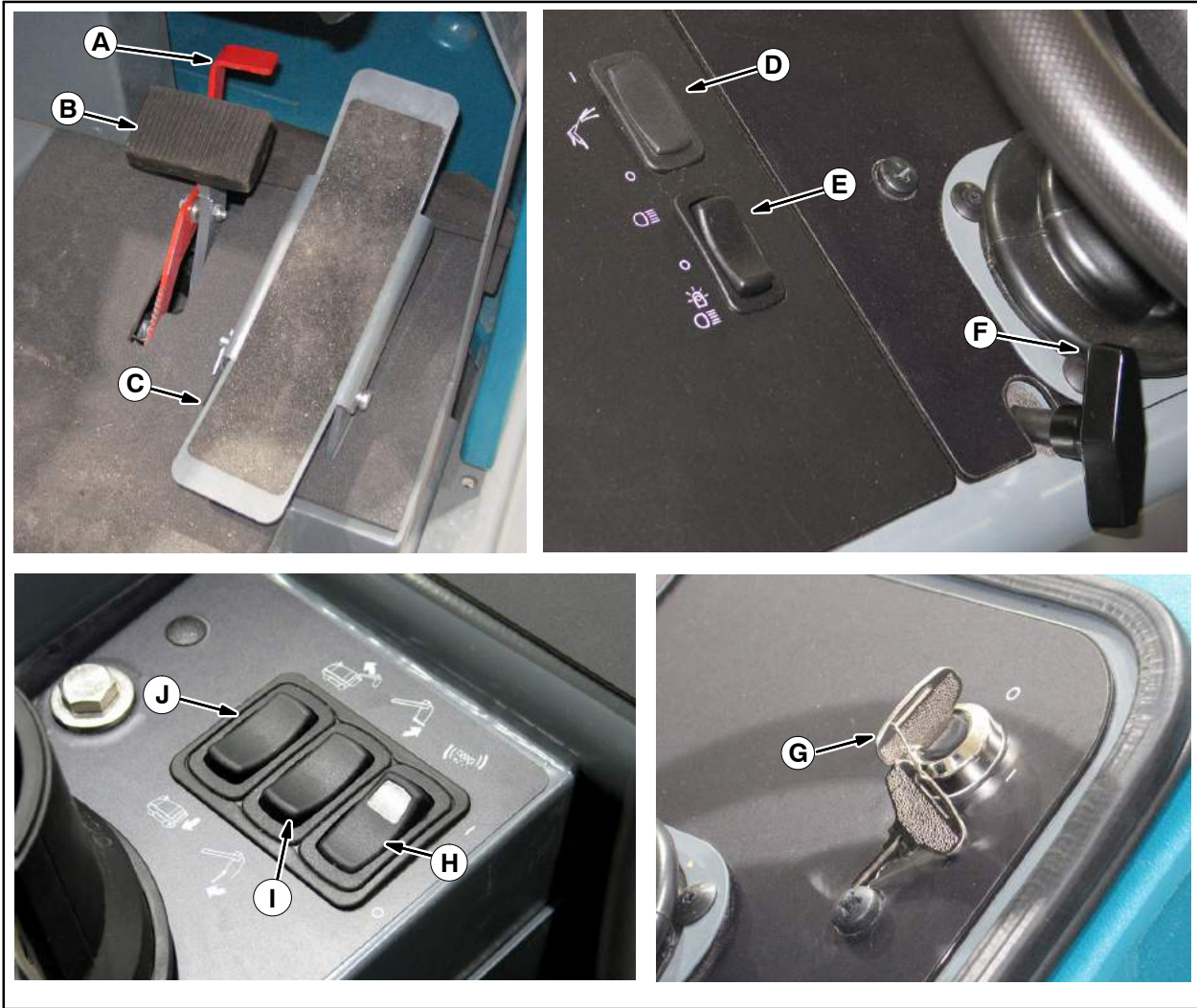

- A. Parking brake pedal
- B. Brake pedal
- C. Directional pedal
- D. Spray nozzle switch / High pressure washer switch (option)
- E. Operating / Hazard lights switch
- F. Steering column tilt knob
- G. Ignition switch
- H. Filter shaker switch
- I. Hopper door open / close switch
- J. Hopper raise / lower switch

STANDARD TOUCH PANEL

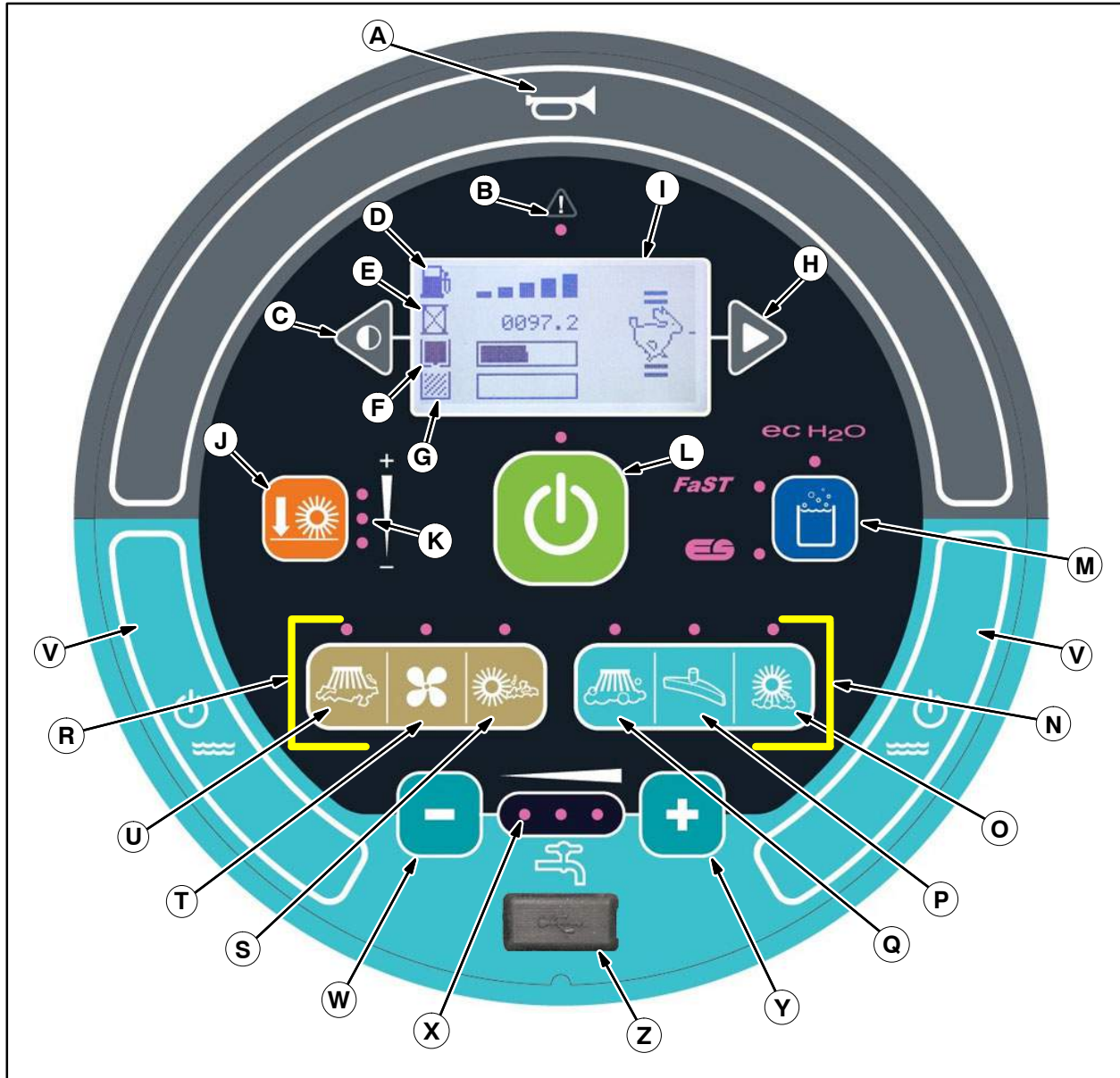

- | | |
|--|--|
| <p>A. Horn
 B. Fault / Alert indicator light
 C. Contrast control button
 D. Fuel level indicator
 E. Hour meter
 F. Solution tank indicator
 G. Recovery tank full indicator
 H. Engine speed button
 I. LCD display
 J. Brush pressure button
 K. Brush pressure indicator lights
 L. 1-STEP button
 M. ec-H₂O / ES (Extended Scrub / FaST) button (Option)</p> | <p>N. Scrubbing buttons (indicated in blue)
 O. Scrubbing main brush button
 P. Scrubbing vacuum fan / squeegee button
 Q. Scrubbing side brush button (Option)
 R. Sweeping buttons (Indicated in brown)
 S. Sweeping main brush button
 T. Sweeping vacuum button button
 U. Sweeping side brush button
 V. Solution on / off buttons
 W. Solution flow decrease button (-)
 X. Solution flow indicator lights
 Y. Solution flow increase button (+)
 Z. USB port (Service only)</p> |
|--|--|

OPERATION



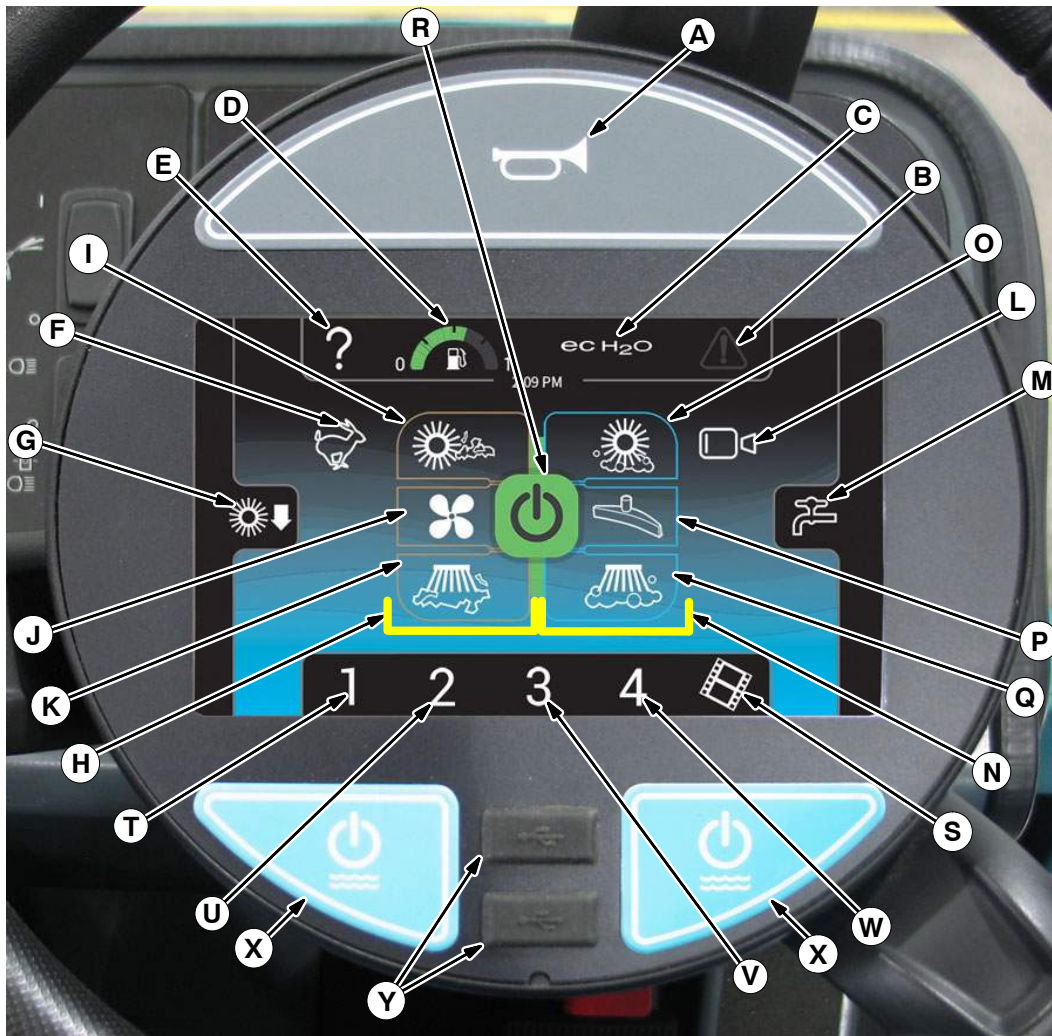



















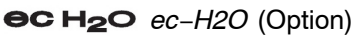
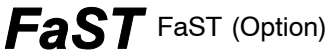

PRO-PANEL CONTROLS



- A. Horn
- B. Fault / Alert indicator light
- C. ec-H₂O / ES (Extended Scrub / FaST button (Option)
- D. Machine status button
- E. Help button
- F. Engine speed button
- G. Main brush pressure access button
- H. Sweeping buttons (Indicated in brown)
- I. Sweeping main brush button
- J. Sweeping vacuum fan button
- K. Sweeping side brush button (Option)
- L. Rearview camera button
- M. Solution control access button
- N. Scrubbing buttons (Indicated in blue)
- O. Scrubbing main brush button
- P. Scrubbing vacuum fan / squeegee button
- Q. Scrubbing side brush (Option)
- R. 1-STEP button
- S. Video help
- T. Zone control 1 button
- U. Zone control 2 button
- V. Zone control 3 button
- W. Zone control 4 button
- X. Solution on / off buttons
- Y. USB ports (Service only)

SYMBOL DEFINITIONS

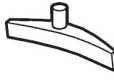
These symbols are used on the machine to identify controls, displays, and features.

	Horn		Solution decrease (-)
	Fault / Alert indicator		Solution increase (+)
	Recovery tank		Solution flow
	Solution tank		Solution On / Off
	Main brush pressure		On
	1-STEP		Off
	ES (Extended Scrub) (Option)		ec-H ₂ O (Option)
	FaST (Option)		Unleaded fuel only
	Filter shaker		Scrub mode
	Operating lights / Hazard light		Sweeping side brush
	Headlights		Sweeping vacuum fan
	Spray nozzle (Option)		Sweeping main brush
	Scrubbing side brush		Scrubbing vacuum fan / squeegee
	Scrubbing main brush		Jack point

OPERATION



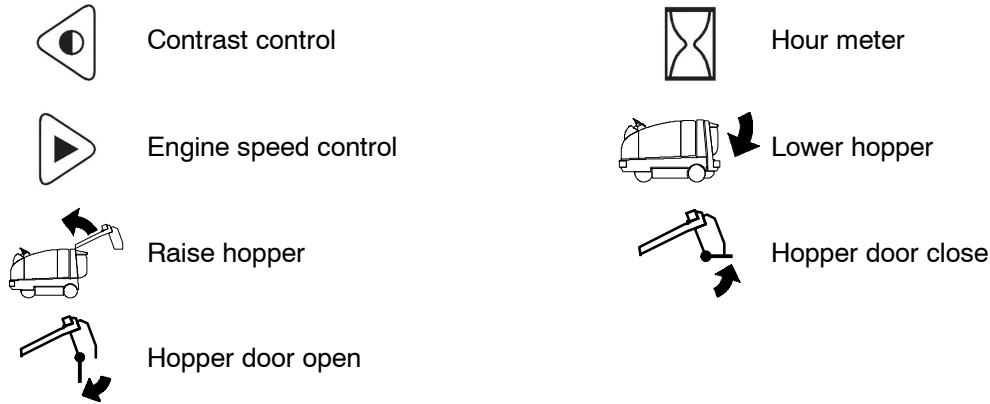























Standard Panel Symbols



Pro- Panel Symbols



Pro-Panel Symbols

	Control help		Video help
	About		Video button
	Backspace		Video list button
	Rearview camera		Home (main operating screen)
	Up arrow		Down arrow
	Disable login		Back arrow
	Add / Edit profiles		Enable login
	Operator		Calibrate touch
	Supervisor		Checklist setup
	Edit profile		Export all
	Add profile		Export new
	Delete profile		Export checklists
	Copy profile		Enter

OPERATION

OPERATION OF CONTROLS – STANDARD PANEL

FUEL INDICATOR

GASOLINE MACHINES

For gasoline machines, the *Fuel indicator* displays the amount of fuel left in the tank. The fault indicator will flash and a low fuel message will appear when the tank is near empty.

NOTE: Do not use leaded fuels. Leaded fuels will permanently damage the system oxygen sensor and catalytic converter.

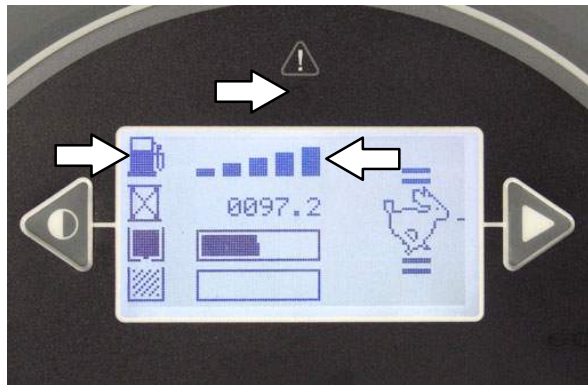

LPG MACHINES

For LPG machines, the *Fuel indicator* does NOT display the amount of fuel in the LPG tank. It will display all the indicator bars to show that some fuel is in the tank. When the LPG tank is near empty, the fault indicator will flash and a low fuel message will appear.

The *LPG fuel gauge* on the tank displays the amount of fuel in the LPG tank.

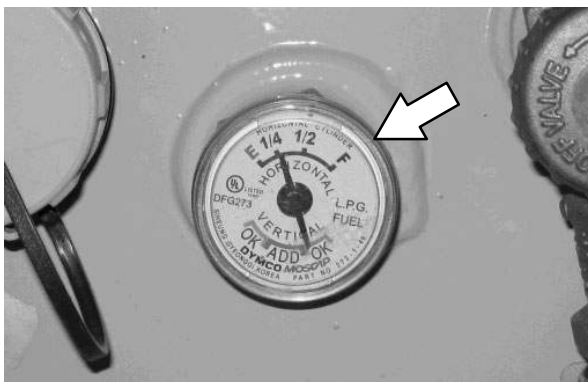

OUR METER

The *Hour meter* records the hours the machine was operated. Use this information to determine machine service intervals.



RECOVERY TANK FULL INDICATOR

The *recovery tank full indicator* displays when the recovery tank is full. All scrubbing functions will stop when the recovery tank is full. Empty the recovery tank when the indicator box is filled.

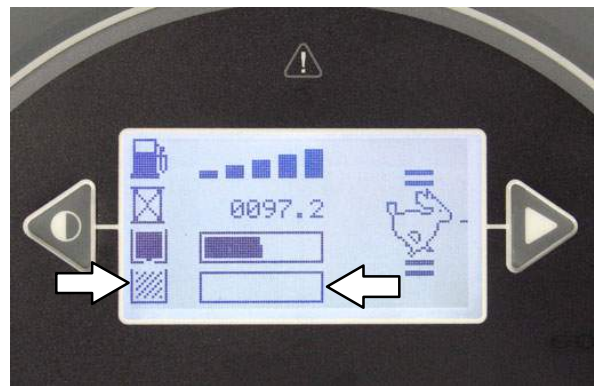

SOLUTION TANK INDICATOR

The *solution tank indicator* displays the amount of liquid in the solution tank. Refill the solution tank when the indicator box is empty. The machine will stop scrubbing when the solution tank is empty.



CONTRAST CONTROL BUTTON

Use the *contrast control button* to darken / lighten the LCD display.



ENGINE SPEED BUTTON

The engine speed is controlled automatically when the *1-STEP button* is pressed. When not sweeping or scrubbing, press the *engine speed button* to increase the engine RPM for increased travel speed. Press the *engine speed button* again to reduce the engine RPM.

The bars above and below the engine speed icon indicate engine speed setting. When two thinner bars appear above and below the icon and the icon appears as a line figure the engine is in the low setting.

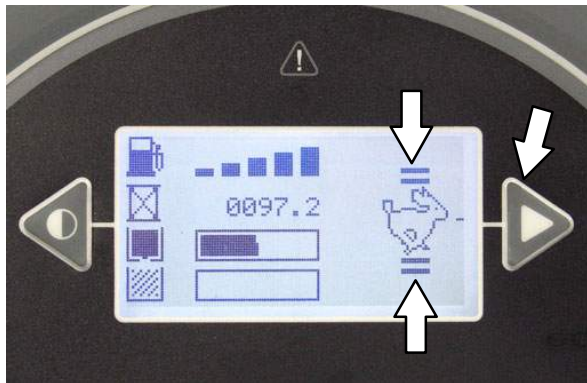

When two thicker bars appear above and below the engine speed icon and the thinner bars and the icon is solid the engine is in the high setting.

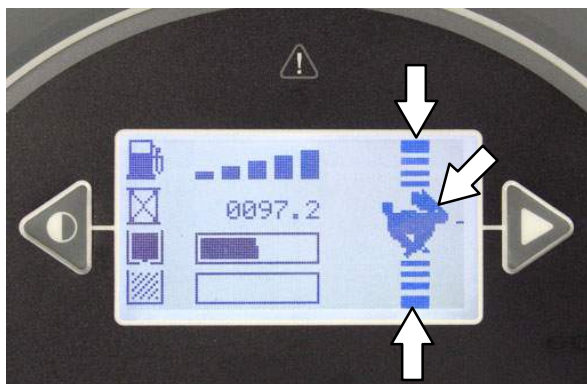

1-STEP BUTTON

Press the *1-STEP button* to activate all selected sweeping and scrubbing functions. Prior to the *1-STEP button* being pushed, the lights above all the selected sweeping / scrubbing functions will be on but the selected functions will be in the standby mode until the *1-STEP button* is pressed. Press the *1-STEP button* again when finished cleaning to stop all scrubbing or sweeping functions.

NOTE: The squeegee will remain down and the vacuum fan will remain on for a few seconds to pick up remaining water after the 1-STEP button is deactivated.

The indicator light above the button will illuminate when the *1-STEP button* is activated.

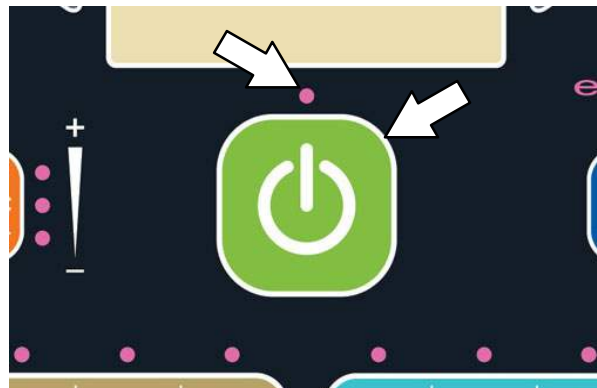

SWEEPING SIDE BRUSH BUTTON (OPTION)

Turn on the sweeping side brush: Press the *sweeping side brush button*. The indicator light will illuminate.

Turn off the sweeping side brush: Press the *sweeping side brush button*. The indicator light will turn off.

NOTE: The sweeping side brushes cannot operate independently from the main sweep brushes. The main sweep brushes also come on when the sweeping side brush button is pushed.

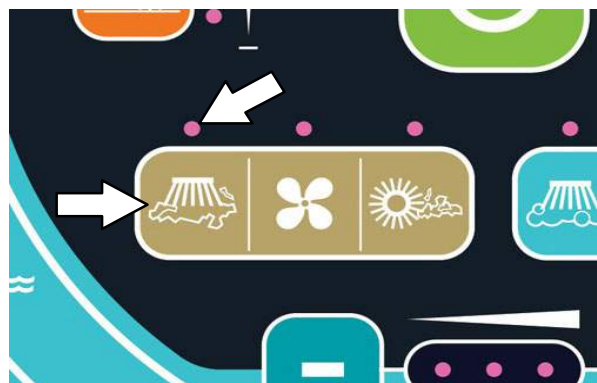

OPERATION

SWEEPING VACUUM FAN BUTTON

Turn on the sweeping vacuum fan: Press the *sweeping vacuum fan button*. The indicator light will illuminate.

Turn off the sweeping vacuum fan: Press the *sweeping vacuum fan button*. The indicator light will turn off.

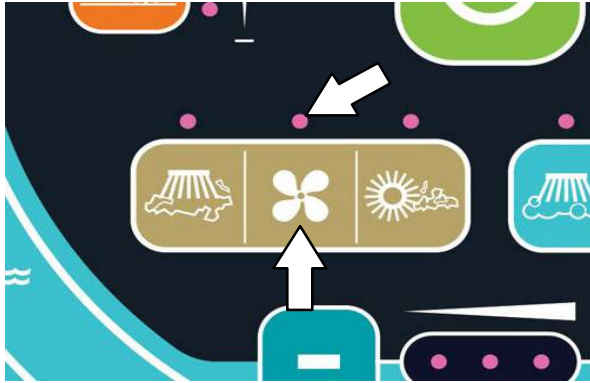

SWEEPING MAIN BRUSH BUTTON

Turn on the sweeping main brush: Press the *sweeping main brush button*. The indicator light will illuminate.

Turn off the sweeping main brush: Press the *sweeping main brush button*. The indicator light will turn off.

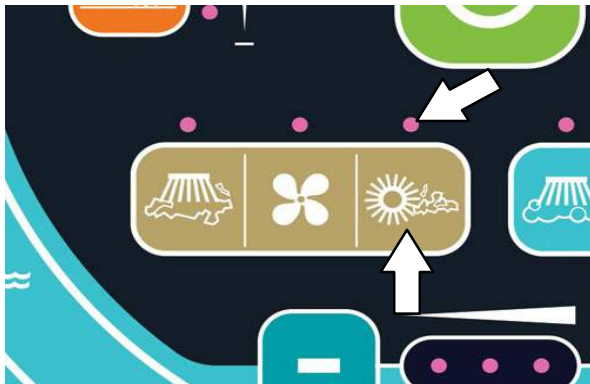

NOTE: The sweeping mode and the scrubbing mode cannot both function at the same time. The sweeping mode will cease operating and the scrubbing mode will begin operating if any scrub button is pressed while the machine is in the sweeping mode.

SCRUBBING SIDE BRUSH BUTTON (OPTION)

Turn on the scrubbing side brush: Press the *scrubbing side brush button*. The indicator light will illuminate.

Turn off the scrubbing side brush: Press the *scrubbing side brush button*. The indicator light will turn off.

NOTE: The scrubbing side brush cannot operate independently from the main scrub brushes. The main scrub brushes also come on when the scrubbing side brush button is pushed.

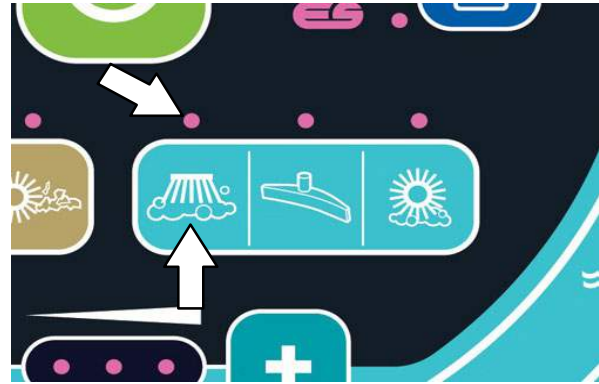

SCRUBBING VACUUM FAN / SQUEEGEE BUTTON

Lower squeegee and turn vacuum fan on: Press the *scrubbing vacuum fan / squeegee button*. The indicator light will illuminate.

Raise squeegee and turn vacuum fan off: Press the *scrubbing vacuum fan / squeegee button*. The indicator light will turn off.

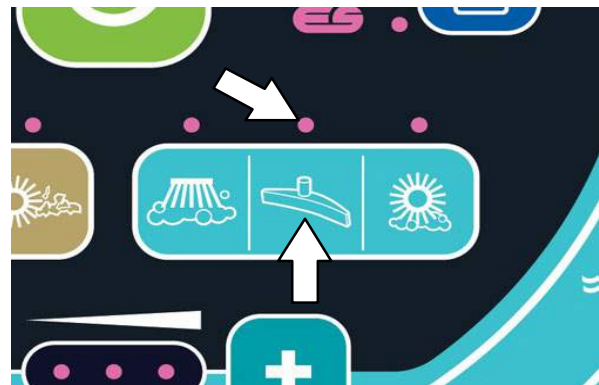

SCRUBBING MAIN BRUSH BUTTON

Turn on the scrubbing main brush: Press the *scrubbing main brush button*. The indicator light will illuminate.

Turn off the scrubbing main brush: Press the *scrubbing main brush button*. The indicator light will turn off.

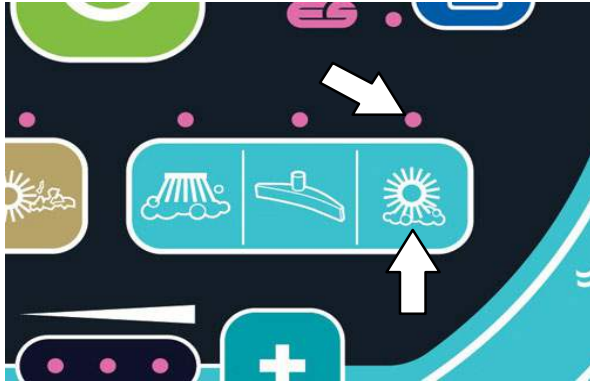

NOTE: The scrubbing mode and the sweeping mode cannot both function at the same time. The scrubbing mode will cease operating and the sweeping mode will begin operating if any sweep button is pressed while the machine is in the scrubbing mode.

SOLUTION ON / OFF BUTTON

The solution flow is designed to stay on whenever the scrub brushes are on. It can be turned off for ten seconds with the *solution on / off button* to go around corners, etc. See also *SETTING THE SOLUTION FLOW* section.

Shut off the solution flow (for ten seconds) : Press the *solution on / off button*. All the solution flow indicators will turn off. (The solution flow will automatically restart at the end of the 10 second delay).

Turn on the solution flow: Press the *solution on / off button*. The solution flow indicators will turn back on and the solution flow will default to the last setting used.

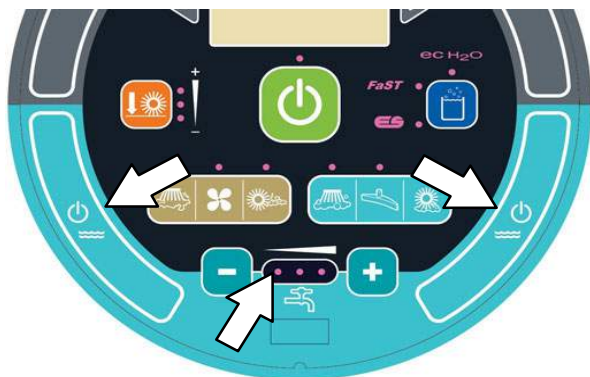

OPERATION OF CONTROLS – PRO-PANEL

PRO-ID LOGIN SCREEN

NOTE: The Pro-ID login screen only applies if the machine was set up with it. Predefined user accounts must be created within the Supervisor Mode.

Use the Pro-ID login screen to log into the machine.

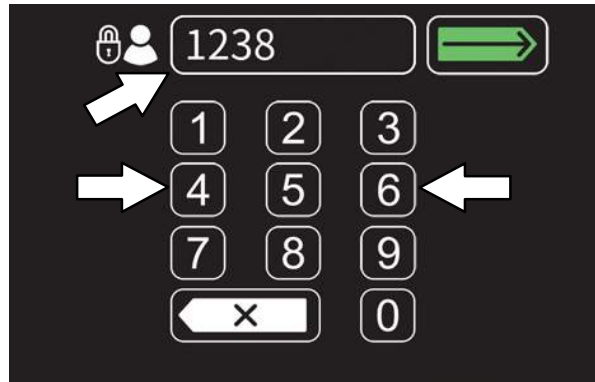

Use the keypad to enter the user login number into the display above the keypad.



Press the Enter button to log into the machine.



Press the backspace button if necessary to delete and reenter a number.

When the Pro-Panel is in the Supervisor Mode, a gear symbol will appear in the lower right part of the screen. When it is in the Operator Mode, a video symbol will appear.

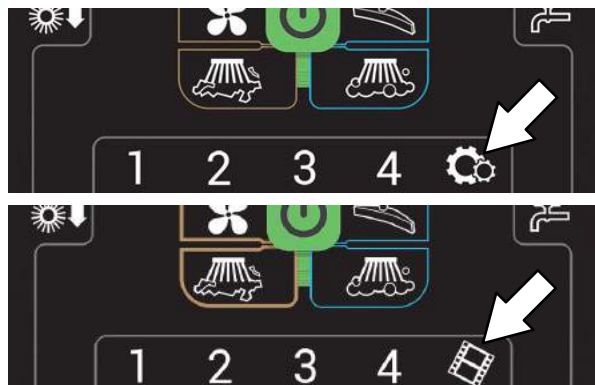



OPERATION

MACHINE STATUS BUTTON

The *machine status button* allows access to four different machine status indicators. The default display shows the fuel indicator when the machine is turned on. Any of the four indicators can be set as the default display until the machine is turned off.

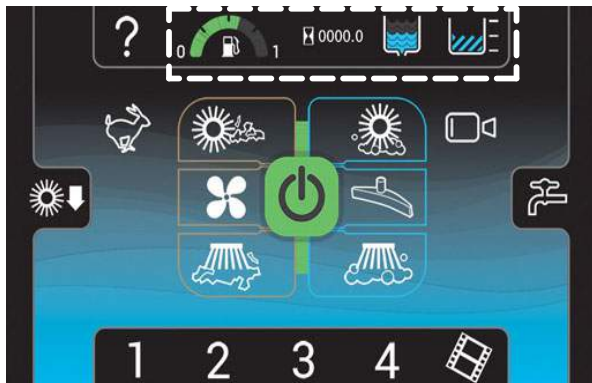
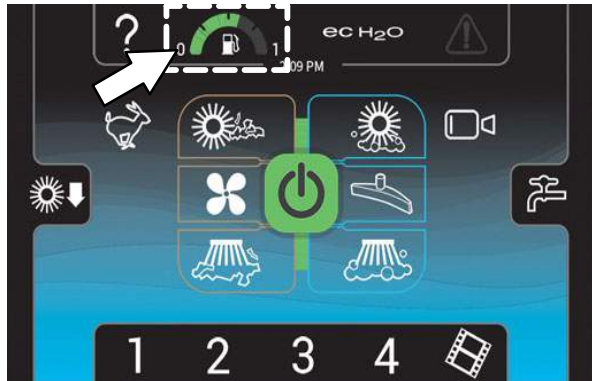
Press the *machine status button* to access all four machine status buttons. All four machine status buttons appear in the display for several seconds until the default buttons reappear in the display.





 For Gasoline machines: The *Fuel indicator* displays the amount of fuel left in the tank. The fault indicator will flash and a low fuel message will appear when the tank is near empty.

 For LPG machines: The *Fuel indicator* does NOT display the amount of fuel in the LPG tank. When the LPG tank is near empty, the fault indicator will flash and a low fuel message will appear.

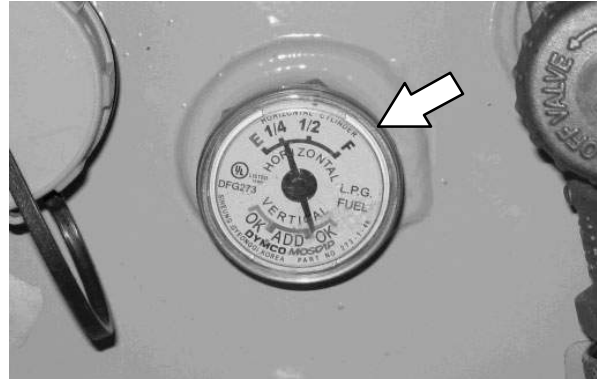
The LPG *fuel gauge* on the tank displays the amount of fuel in the LPG tank.



 The *hour meter* records the hours the machine was operated. Use this information to determine machine service intervals.

 The *solution tank indicator* displays the amount of liquid in the solution tank. Refill the solution tank when there are no longer any bars shown in the display. The machine will stop scrubbing when the solution tank is empty.

 The *recovery tank full indicator* displays FULL when the recovery tank is full. All scrubbing functions will stop when the recovery tank is full. Empty the recovery tank when the indicator displays FULL.

CHANGING THE DEFAULT BUTTON

Press the desired machine status button while all four machine status buttons appear in the display to change it to the new default button. The other three machine status buttons will disappear from the display and the newly selected machine status button will become the default until the machine is turned off. The *fuel indicator button* will once again be the default when the machine is turned on.

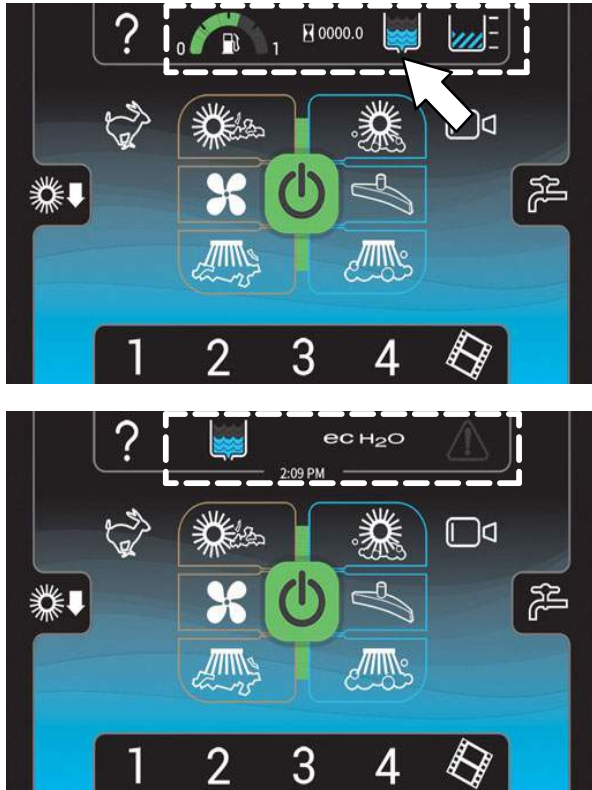

1-STEP BUTTON

Press the *1-STEP button* to activate all selected sweeping or scrubbing functions. Press the *1-STEP button* again when finished cleaning to stop all scrubbing or sweeping functions.

NOTE: The squeegee will remain down and the vacuum fan will remain on for a few seconds to pick up remaining water after the 1-STEP button is deactivated.

The *1-STEP button* and all selected scrubbing or sweeping function buttons will illuminate when the *1-STEP button* is pressed.

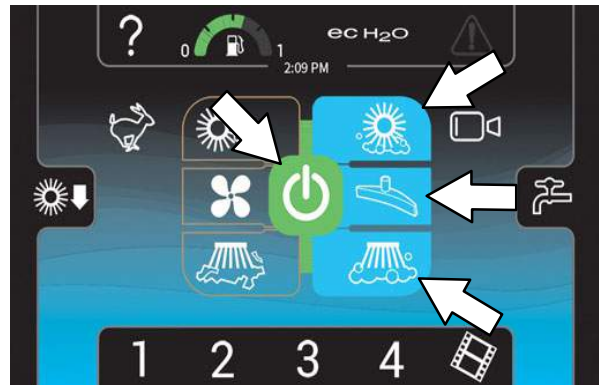

The edges of all selected sweeping and scrubbing buttons will be illuminated to show that they are in the standby mode prior to the *1-STEP button* being pressed. The selected buttons will become fully illuminated when the *1-STEP button* is pressed.

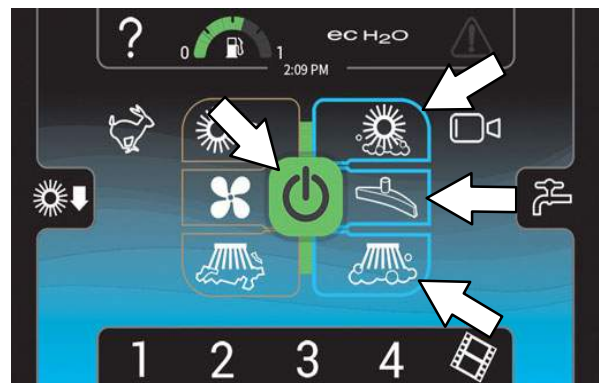

OPERATION

SWEEPING MAIN BRUSH BUTTON

Turn on the sweeping main brush: Press the *sweeping main brush button*. The button will illuminate.

Turn off the sweeping main brush: Press the *sweeping main brush button*. The button will turn off.

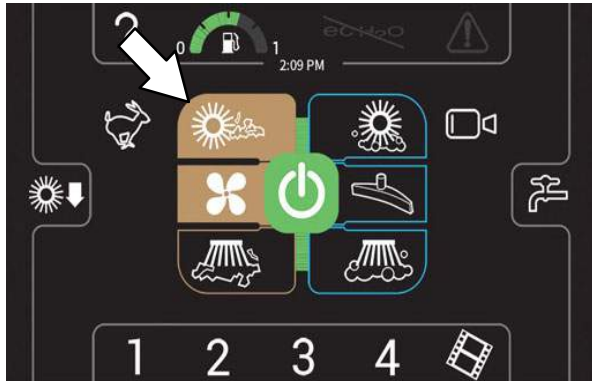

NOTE: The sweeping mode and the scrubbing mode cannot both function at the same time. The sweeping mode will cease operating and the scrubbing mode will begin operating if any scrub button is pressed while the machine is in the sweeping mode.

SWEEPING VACUUM FAN BUTTON

Turn on the sweeping vacuum fan: Press the *sweeping vacuum fan button*. The button will illuminate.

Turn off the sweeping vacuum fan: Press the *sweeping vacuum fan button*. The button will turn off.

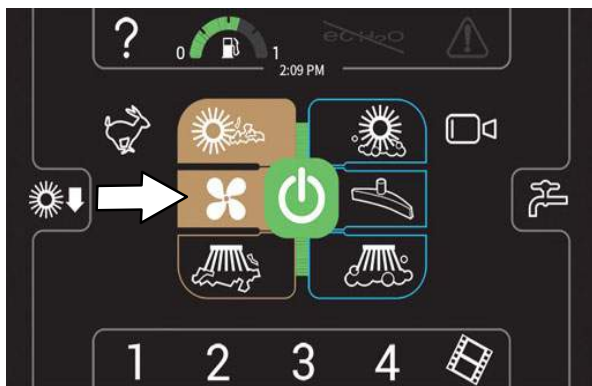

SWEEPING SIDE BRUSH BUTTON (OPTION)

Turn on the sweeping side brush: Press the *sweeping side brush button*. The button will illuminate.

Turn off the sweeping side brush: Press the *sweeping side brush button*. The button will turn off.

NOTE: The sweeping side brushes cannot operate independently from the main sweep brushes. The main sweep brushes also come on when the sweeping side brush button is pushed.

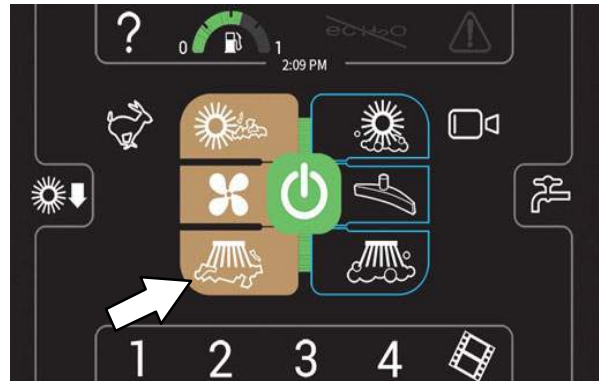

SCRUBBING MAIN BRUSH BUTTON

Turn on the scrubbing main brush: Press the *scrubbing main brush button*. The button will illuminate.

Turn off the scrubbing main brush: Press the *scrubbing main brush button*. The button will turn off.



The scrubbing mode and the sweeping mode cannot both function at the same time. The scrubbing mode will cease operating and the sweeping mode will begin operating if any sweep button is pressed while the machine is in the scrubbing mode.

SCRUBBING VACUUM FAN / SQUEEGEE BUTTON

Lower squeegee and turn vacuum fan on: Press the *scrubbing vacuum fan / squeegee button*. The button will illuminate.

Raise squeegee and turn vacuum fan off: Press the *vacuum fan / squeegee button*. The button will turn off.



SCRUBBING SIDE BRUSH BUTTON (OPTION)

Turn on the scrubbing side brush: Press the *scrubbing side brush button*. The button will illuminate.

Turn off the scrubbing side brush: Press the *scrubbing side brush button*. The button will turn off.

NOTE: The scrubbing side brush cannot operate independently from the main scrub brushes. The main scrub brushes also come on when the scrubbing side brush button is pushed.



SOLUTION ON / OFF BUTTONS

The solution flow is designed to stay on whenever the scrub brushes are on. It can be turned off for ten seconds with the *solution on / off button* to go around corners, etc. See also *SETTING THE SOLUTION FLOW* section.

Shut off the solution flow (for ten seconds): Press the *solution on / off button*. All the solution flow indicators will turn off. (The solution flow will automatically restart at the end of the 10 second delay).

Turn on the solution flow: Press the *solution on / off button*. The solution indicators will turn back on and the solution flow will default to the last setting used.

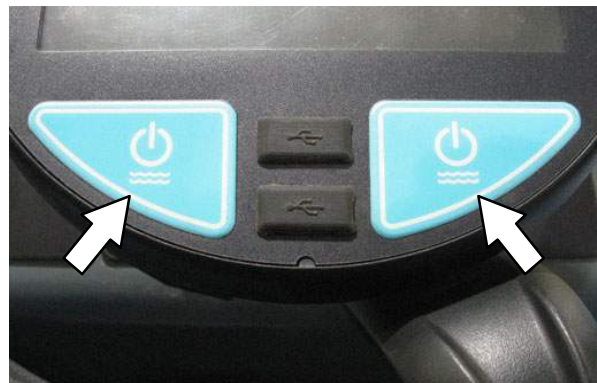

OPERATION

ENGINE SPEED BUTTON

The engine speed is controlled automatically when the *1-STEP button* is pressed. When not sweeping or scrubbing, press the *engine speed button* to increase the engine RPM for increased travel speed. Press the *engine speed button* again to reduce the engine RPM.

The *engine speed button* is illuminated when the engine is in the high speed setting.

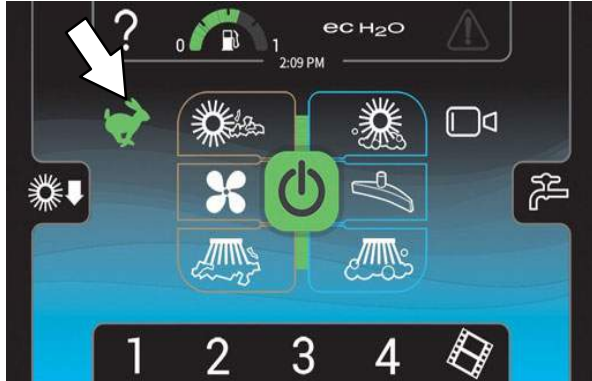

The *engine speed button* is off when the engine is in the low speed setting.

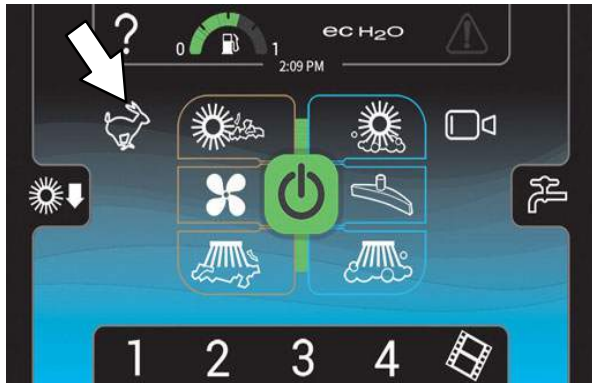

ZONE CONTROL BUTTONS

Machines equipped with the Pro-Panel can be pre-programmed for up to four preset scrubbing / sweeping settings for different floor cleaning applications. These must be set up ahead of time using the supervisor mode. See *PROGRAMMING THE ZONE CONTROL BUTTONS* section.

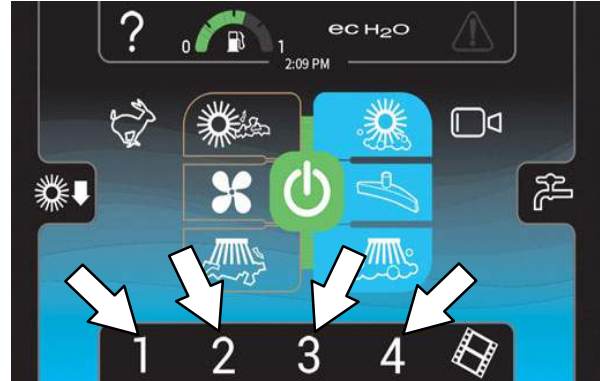

Press the required zone control button. The selected preset button will illuminate and the name of the zone appears above the button. The *solution flow indicator bar* / adjustment buttons and *brush pressure indicator bar* / adjustment buttons briefly appear in the display to show the settings for the selected zone.



REARVIEW CAMERA BUTTON

Press the *rearview camera button* to check cleaning performance. The rearview camera screen will appear in the control panel display for a short amount of time. The main operating screen returns to the control panel after the rearview camera times out. Touch anywhere on the control panel display to turn off the rearview camera and return to the main operating screen.

FOR SAFETY: When using machine, always be aware of your surroundings.



The camera automatically comes on when the bottom of the *directional pedal* is pressed to place the machine in reverse and remains on the entire time the machine is in reverse.

The rearview camera is located on the recovery tank, above where the vacuum hose is attached to the recovery tank.

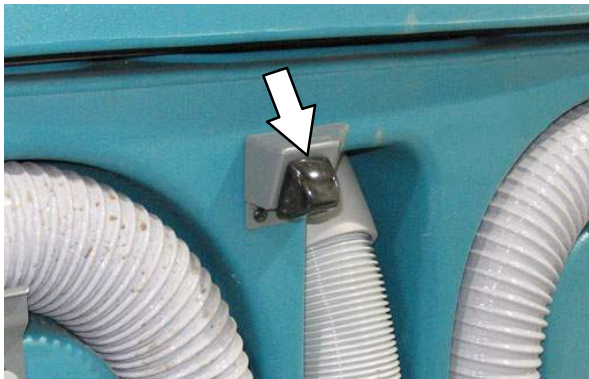

OPERATION

HELP BUTTON





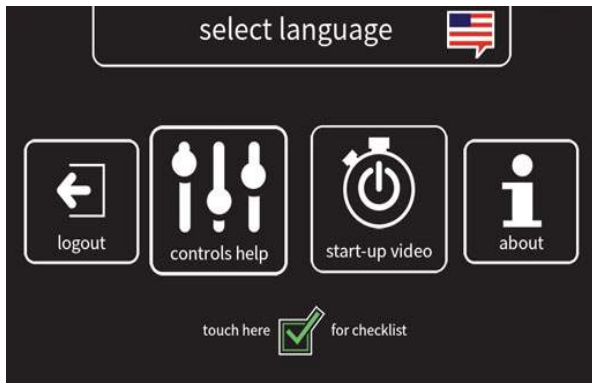

FOR SAFETY: When using machine, do not access the video / help screens while the machine is moving. (Pro-Panel)

Press the *help* button to access the help screen.







Press the applicable button for the help topic needed.



-  Press the *select language* button to go to the language screen.
-  Press the *login / logout* button to log in / log out of the machine operating system.
-  Press the *controls help* button to access the controls help screen.
-  Press the *start-up video* button to watch the start-up video.
-  Press the *about* button to access machine operating system information.
-  Press the *Pre-Operation Checklist* button to access the Pre-Operation Checklist.



Press the select language button. Select an applicable language from the list to change the machine operating system language. A flag designating the country language selected will appear at the top of the screen.



-  Press the *down arrow* button to scroll down through the language list.
-  Press the *up arrow* button to scroll up through the language list.
-  Press the *back arrow* button to return to the previous screen
-  Press the *Pre-Operation Checklist* button to access the Pre-Operation Checklist.





Press the *control help* button to access information about the Pro-Panel controls.

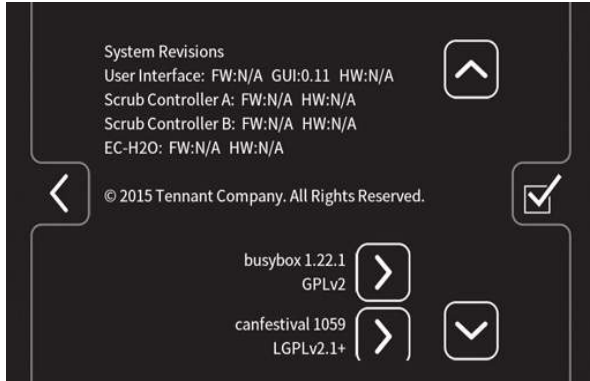

-  Press the *back arrow* button to return to the main help screen.
-  Press the *home* button to return to the main operating screen.

Press the *about* button to access information about the operating system software.



-  Press the *down arrow button* to scroll down through the list.
-  Press the *up arrow button* to scroll up through the list.
-  Press the *Pre-Operation Checklist button* to access the Pre-Operation Checklist.
-  Press the *back arrow button* to return to the previous screen.
-  Press the *forward arrow button* to access machine information from the list.

OPERATION





VIDEO HELP BUTTON

FOR SAFETY: When using machine, do not access the video / help screens while the machine is moving. (Pro-Panel)

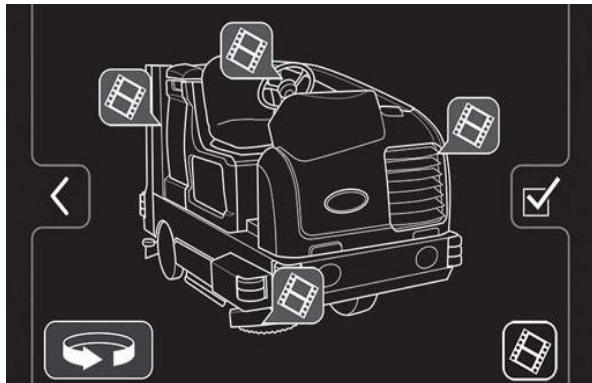
NOTE: Stop machine before accessing video help screen / videos. Do Not access the video help screen / videos while the machine is moving.





Press the *video button* to access the video help screen.



-  Press the applicable *video button* to view the help video for a particular machine component.
-  Press the *rotate machine button* to access video help buttons located on the front, back, or other side of the machine.
-  Press the home button to return to the main operating screen.
-  Press the *back arrow button* to return to the previous screen.
-  Press the *video list button* to access a text list of all help videos.

Select an applicable video from the list to view the video if the *video list button* was pressed to access the video list.







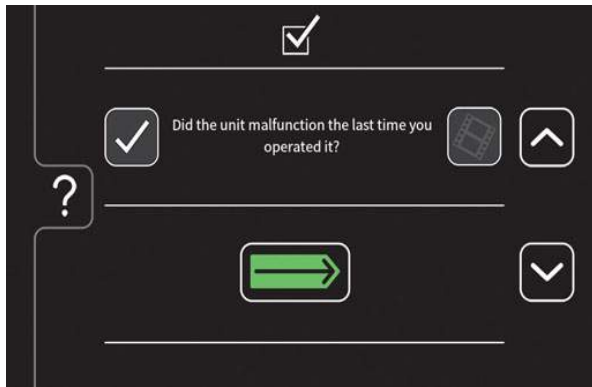

-  Press the *down arrow button* to scroll down through the list.
-  Press the *up arrow button* to scroll up through the list.
-  Press the *Pre-Operation Checklist button* to access the Pre-Operation Checklist.
-  Press the *back arrow button* to return to the previous screen.

COMPLETING THE PRO-CHECK PRE-OPERATION CHECKLIST

Machines equipped with the Pro-Panel controls can be pre-programmed with the Pro-Check Pre-Operation Checklist the operator must complete before operating the machine.



-  Press the *down arrow button* to scroll down through checklist.
-  Press the *up arrow button* to scroll up through checklist.
-  Press the *complete (check mark) button* to confirm the checklist item was checked. Press the *problem found (X) button* if a problem is found when checklist item is checked.
-  Press the *video help button* to view the video related to a particular checklist item.
-  Press the *enter button* when ready to start using the machine after completing the checklist.

 Press the *help button* to access the Pro-Check Pre-Operation Checklist help screen.

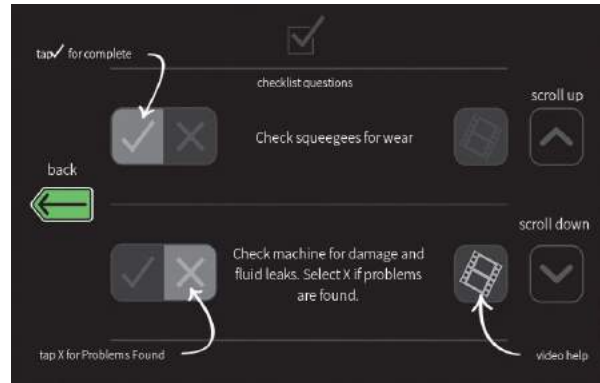

 Press the *back button* to return to the Pre-Operation Checklist.

The operator is not allowed to access the main operating screen / use machine until the Pro-Check Pre-Operation Checklist is completed. Press the *back arrow button* to return to the checklist screen.

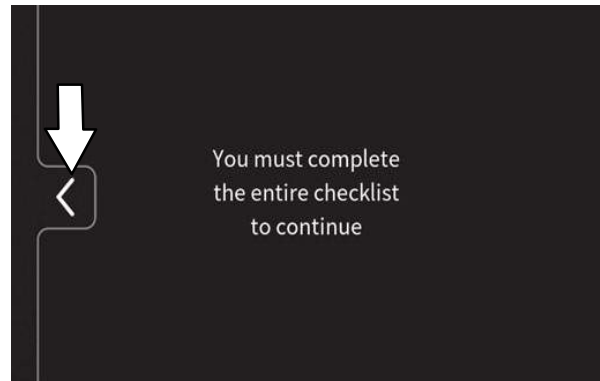

OPERATION

OPERATION OF CONTROLS – ALL MACHINES

OPERATING LIGHTS

Push the top of the *Operating / hazard light switch* to turn on the headlights and taillights. Return the light switch to the center position to turn off the lights.



HAZARD LIGHT (OPTION)

Press the bottom of the *Operating / hazard light switch* to turn on the hazard light, headlights, and taillights. Return the light switch to the center position to turn off the lights.



FILTER SHAKER SWITCH

Press the *filter shaker switch*. The filter shaker will operate for 30 seconds.

The *filter shaker switch* light will illuminate while the filter shaker is operating. Press the top of the *filter shaker switch* again if necessary to stop the filter shaker.



OPERATOR SEAT

The operator seat has two adjustments: operator weight and front to back.

The weight adjustment knob controls the firmness of the operator seat.

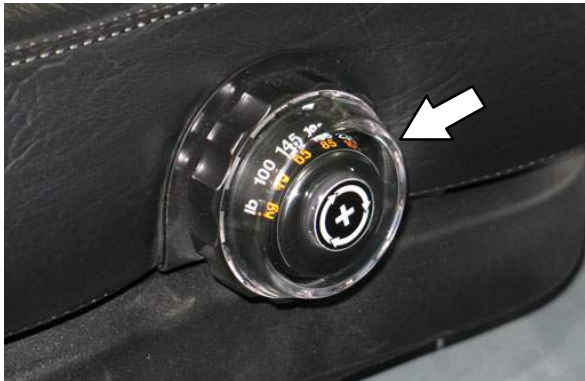

Increase firmness: Turn the weight adjustment knob clockwise.

Decrease firmness: Turn the weight adjustment knob counterclockwise.

The front-to-back adjustment lever adjusts the seat position.



Adjust: Pull the lever out and slide the seat to the desired position. Release the lever to lock the seat into place.

SEAT BELTS

FOR SAFETY: Before starting machine, adjust seat and fasten seat belt.



STEERING COLUMN TILT KNOB

1. Pull the *Steering column tilt knob* and adjust the steering column to the desired height.
2. Release the *Steering column tilt handle*.

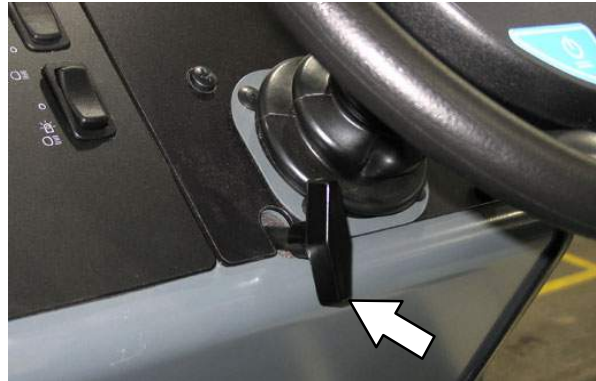

BRAKE PEDAL

Press the *Brake pedal* to stop the machine.



PARKING BRAKE PEDAL

Press the *Brake pedal* down as far as possible and use toe to lock the *Parking brake pedal* into place. Press the *Brake pedal* to release the parking brake. The *Parking brake pedal* will return to the unlocked position.



OPERATION

DIRECTIONAL PEDAL

Press the top of the *Directional pedal* to move forward and the bottom of the pedal to move backward. The backup lights will come on when the machine is in reverse. The pedal returns to the neutral position when it is released.

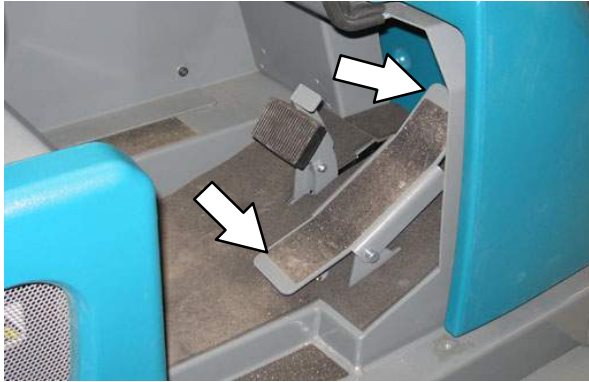

NOTE: An audible alarm will sound and the backup light will flash when backing the machine if equipped with the optional backup alarm.

SQUEEGEE PROTECTORS (OPTION)

The rear and side squeegee protectors help protect the rear squeegee from being damaged.

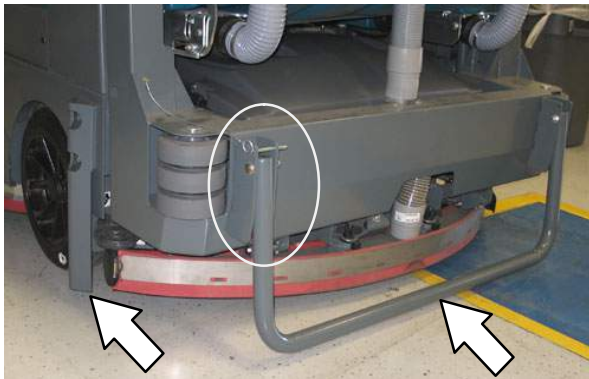

To engage the rear squeegee protector, pull the pin, lower the protector bar, and reinsert the pin.



HOW THE MACHINE WORKS

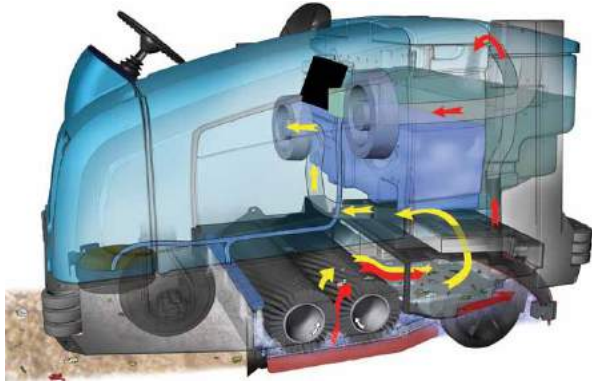

This machine can effectively scrub or sweep dirty floors. The *1-STEP button* makes it possible to immediately begin scrubbing or sweeping.

The *1-STEP button* operates either the sweeping functions or scrubbing functions. (The machine also sweeps while scrubbing).

When in the conventional Scrub mode, a water and detergent mixture is used to scrub the floor.

When in the optional FaST (Foam scrubbing) mode, the FaST scrubbing system mixes the FaST-PAK concentrate with a small amount of water, creating a large volume of expanded wet foam. The FaST system can be used with all double scrubbing and heavy duty scrubbing applications.

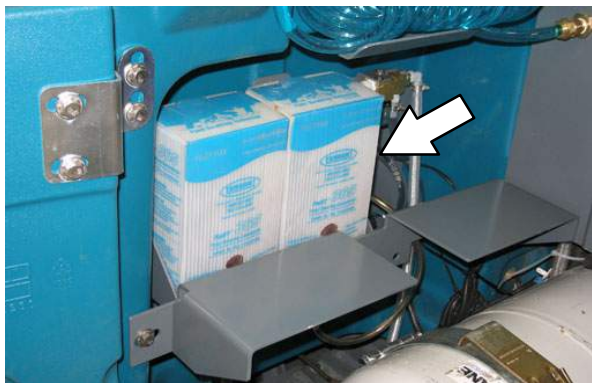

When in the optional ES (Extended Scrub) mode, the dirty solution in the recovery tank is filtered through the ES system and returned to the solution tank for reuse. Detergent is then injected into the returned solution to revitalize the cleaning capability of the solution.

When in the optional *ec-H2O* (electrically converted water) mode, normal water passes through a module where it is oxygenated and charged with an electric current. The electrically converted water changes into a blended acidic and alkaline solution forming a neutral pH cleaner. The converted water attacks the dirt, breaks it into smaller particles, and pulls it off the floor surface allowing the machine to easily scrub away the suspended soil. The converted water then returns to normal water in the recovery tank. The *ec-H2O* system can be used while double scrubbing.

BRUSH INFORMATION

For best results, use the correct brush type for the cleaning application. Listed below are the brushes and the applications for which each is best suited.

NOTE: The amount and type of soilage play an important role in determining the type of brushes to use. Contact a Tennant representative for specific recommendations.

PolyPro brush – Heavy duty polypropylene bristles provide a more aggressive cleaning performance and can more easily lift compacted dirt, debris, and sand while offering excellent scrubbing performance.

Polypropylene brush – General purpose polypropylene bristles lift lightly compacted dirt without scuffing high-gloss coated floors.

Polyester brush – Softer general purpose polyester bristles lift light debris while sweeping and gently clean while scrubbing. Perfect for sensitive floor surfaces. Polyester does not absorb water so it is preferred over Nylon in wet applications.

Super AB brush – Nylon fiber impregnated with abrasive grit to remove stains and compacted dirt. Aggressive action on any surface. Performs well on buildup, grease, or tire marks.

WHILE OPERATING THE MACHINE

Pick up oversized debris before scrubbing or sweeping. Pick up wire, string, twine, large pieces of wood, or any other debris that could become wrapped around or tangled in the brushes.

Drive as straight a path as possible. Avoid bumping into posts or scraping the sides of the machine. Overlap the scrub/sweep paths by several centimeters (a few inches).

Avoid turning the steering wheel too sharply when the machine is in motion. The machine is very responsive to the movement of the steering wheel. Avoid sudden turns, except in emergencies.

Adjust the machine speed, brush pressure, and solution flow as required when scrubbing. Use the lowest brush pressure and solution flow settings for best performance. If the machine is equipped with the FaST or *ec-H2O* system, use the FaST or *ec-H2O* system for the best scrubbing results.

Keep the machine moving to prevent damaging floor finishes.

If poor cleaning performance is observed, stop cleaning and refer to *MACHINE TROUBLESHOOTING* in this manual.

Perform the Daily Maintenance Procedures after each use (see *MACHINE MAINTENANCE* in this manual).

Drive the machine slowly on inclines. Use the brake pedal to control machine speed on descending inclines. Scrub with the machine up inclines rather than down inclines.

FOR SAFETY: When using machine, go slowly on inclines and slippery surfaces.

Do not operate machine in areas where the ambient temperature is above 43° C (110° F). Do not operate scrubbing functions in areas where the ambient temperature is below freezing 0° C (32° F).

The maximum rated incline for scrubbing with the machine is 10%. The maximum rated incline during transport of the machine is 14%.

PRE-OPERATION CHECKLIST

- Check the hydraulic fluid level.
- Check the fuel level.
- Check the machine for fluid leaks.
- Check the condition of the main brushes. Remove string, banding, plastic wrap, or other debris wrapped around the brushes.
- Check the main brush compartment right skirts, seals, and squeegee for damage and wear.
- Side Brush Option: Check the condition of the brush. Remove string, banding, plastic wrap, or other debris wrapped around the brush.
- Side Brush Option: Check the condition of the side brush skirt or squeegee.
- Check the radiator and hydraulic cooler fins for debris.
- Check the engine coolant level.
- Check the engine oil level.
- Check the main brush compartment left skirts, seals, and squeegee for damage and wear.
- Check the left solution tank cover seal for damage and wear.
- Check the recovery tank cover seal for damage and wear.
- Clean the vacuum fan debris filter.
- Drain and clean the recovery tank.
- ES Option: Drain and clean the solution tank, float sensor, and ES filter.
- Check the right solution tank cover seal for damage and wear.
- Check the condition of the hopper dust filter and seals.
- Clean the hopper and the debris screen.
- Check the squeegee hose for debris or blockage.
- Check the squeegees for damage, wear, and deflection adjustment.
- FaST Scrubbing: Check the FaST-PAK concentrate agent level. Replace carton as needed. See the INSTALLING THE FaST-PAK CARTON section of the manual.
- FaST Scrubbing: Ensure all conventional cleaning agents are drained and rinsed from the solution tank.
- FaST Scrubbing: Ensure the solution tank is filled with **clear cool water only**.
- Check the horn, headlights, taillights, safety lights, and backup alarm (if equipped).
- Check the brakes and steering for proper operation.
- Check the service records to determine maintenance requirements.

OPERATION

CHANGING THE LPG TANK

FOR SAFETY: Before leaving or servicing machine, stop on level surface, set parking brake, turn off machine, and remove key.

1. Open the side access door.
2. Close the LPG tank service valve.

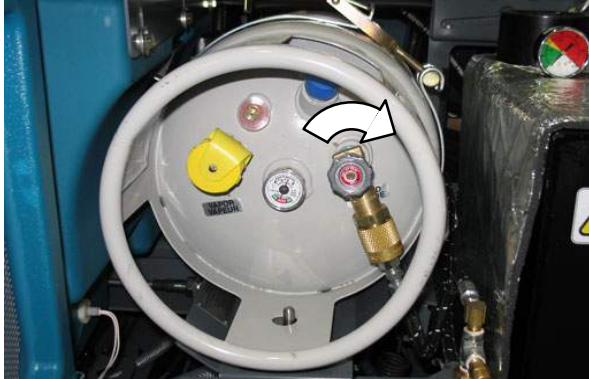

3. Start the machine and operate the engine until it stops from lack of fuel. Turn off the machine.
4. Lift the operator seat open and engage the seat latch so the seat remains open.

FOR SAFETY: When servicing machine, keep flames and sparks away from fuel system service area. Keep area well ventilated.

5. Put on gloves and remove the quick disconnect tank coupling.

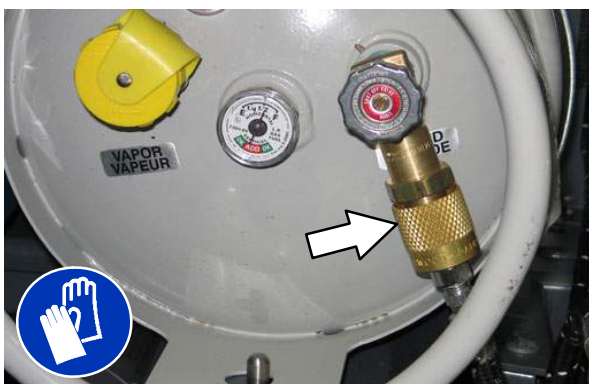

6. Disengage the mounting strap and remove the empty LPG fuel tank.

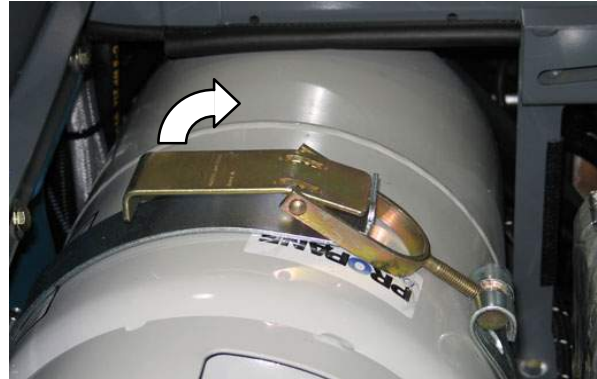

7. Align the hole in the tank collar with the centering pin and carefully place the full LPG tank onto the tray. Secure the tank with mounting strap.

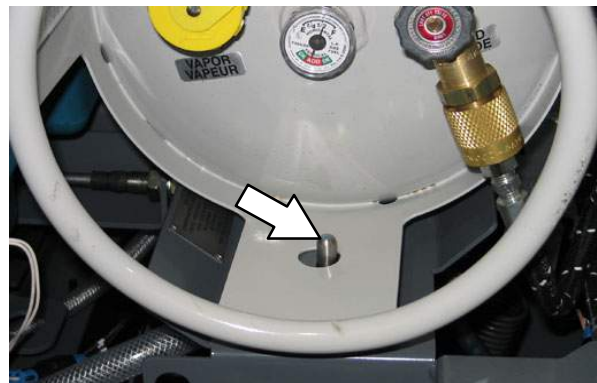

8. Connect the LPG fuel line to the tank service coupling. Make sure the tank service coupling is clean and undamaged and that it matches the fuel line coupling.
9. Slowly open the tank service valve and check for leaks. If a leak is found, immediately close the service valve and inform the appropriate personnel.

STARTING THE MACHINE

1. LPG powered machines: Slowly open the liquid service valve.

NOTE: Opening the service valve too quickly may cause the service check valve to stop the flow of LPG fuel. If the check valve stops the fuel flow, close the service valve, wait a few seconds, and slowly open the valve again.



2. Sit in the operator seat and press the brake pedal or set the parking brake.

FOR SAFETY: When starting machine, keep foot on brake and directional pedal in neutral.

3. Turn the ignition switch key until the engine starts.

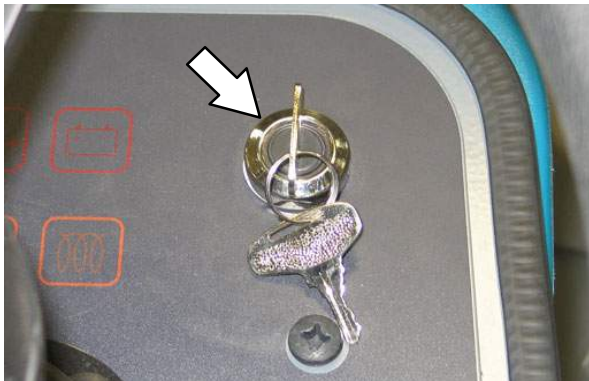

NOTE: Do not operate the starter motor for more than 10 seconds at a time or after the engine has started. Allow the starter to cool 15–20 seconds between starting attempts or damage to the starter motor may occur.

4. Allow the engine and hydraulic system to warm up for three to five minutes.



WARNING: Engine emits toxic gases. Severe respiratory damage or asphyxiation can result. Provide adequate ventilation. Consult with your regulatory authorities for exposure limits. Keep engine properly tuned.

5. Turn on lights.

TURNING OFF THE MACHINE

1. Stop the machine and turn off all scrubbing/sweeping functions.
2. Turn the ignition switch key counter clockwise to turn off the machine. Remain in the operator seat until the engine is off.



CAUTION: LPG engine will run for a few seconds after key is turned off. Apply parking brake before leaving machine.

NOTE: To protect engine emission components on LPG powered machines, the engine will continue to operate for a few seconds after the ignition switch is turned off.

FOR SAFETY: Before leaving or servicing machine, do not park near combustible materials, dust, gases, or liquids. Stop on level surface, set parking brake, turn off machine, and remove key.

OPERATION

FILLING THE SOLUTION TANK

FOAM SCRUBBING (FaST MODE) / ec-H2O SCRUBBING (ec-H2O MODE)

FOR SAFETY: Before leaving or servicing machine, stop on level surface, set parking brake, turn off machine, and remove key.

1. Open either the left or right solution tank fill cover.
2. Fill the solution tank with only clean COOL WATER (less than 21°C / 70°F). DO NOT use hot water or add any conventional floor cleaning detergents or FaST system failure may result.

! WARNING: Flammable materials can cause an explosion or fire. Do not use flammable materials in tank(s).

NOTE: To install or change the FaST-PAK carton, see the REPLACING THE FaST-PAK CARTON section of the manual.



NOTE: Do not use the FaST or ec-H2O system when there are conventional cleaning detergents in the solution tank. Drain, rinse, and refill the solution tank with clear cool water before operating the FaST or ec-H2O system. Conventional cleaning detergents may cause a FaST or ec-H2O system failure.

CONVENTIONAL SCRUBBING MODE

FOR SAFETY: Before leaving or servicing machine, stop on level surface, set parking brake, turn off machine, and remove key.

1. Open either the left or right solution tank fill cover.
2. Partially fill solution tank with water (not to exceed 60°C / 140°F). Pour the required amount of detergent into the solution tank. Fill the solution tank with water until the level is just below the indicator tab.

! WARNING: Flammable materials can cause an explosion or fire. Do not use flammable materials in tank(s).

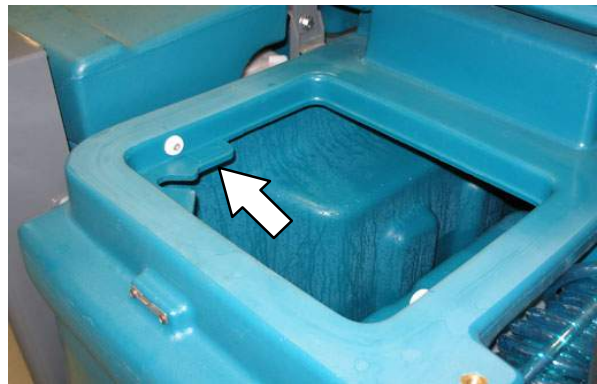

ATTENTION: For Conventional Scrubbing, only use recommended cleaning detergents. Machine damage due to improper detergent usage will void the manufacturer's warranty.

NOTE: Pour a recommended foam control solution into the recovery tank if excessive foam appears. For specific detergent recommendations, contact a TENNANT representative.

ES (EXTENDED SCRUB) MODE WITH AUTO-FILL

FOR SAFETY: Before leaving or servicing machine, stop on level surface, set parking brake, and turn off machine.

1. Connect the hose from the water source (not to exceed 60°C / 140°F) to the auto-fill connection.

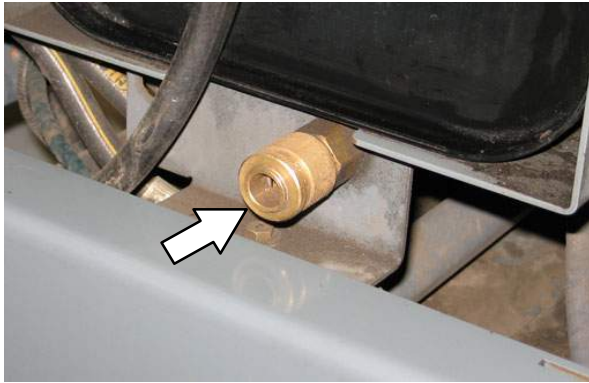

2. Turn the ignition switch to the on position (without starting) and turn on the water source. The auto-fill automatically fills the tanks to the proper level.
3. Fill the detergent tank with the proper detergent.

ATTENTION: For ES Scrubbing, only use recommended low-foaming cleaning detergents. Machine damage due to the use of improper detergent will void the manufacturer's warranty.

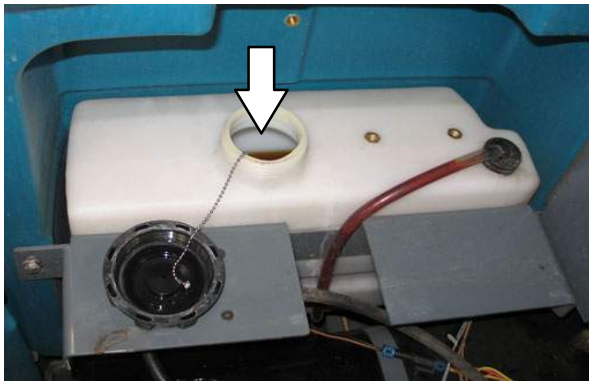

ES (EXTENDED SCRUB) MODE - MANUALLY FILLING TANKS

FOR SAFETY: Before leaving or servicing machine, stop on level surface, set parking brake, and turn off machine.

1. Open either the left or right solution tank cover and fill the solution tank with water (not to exceed 60°C / 140°F) until the level is just below the indicator tab.

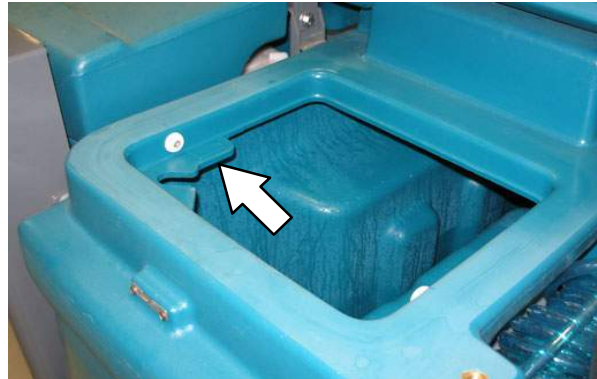

2. Open the recovery tank cover and fill the recovery tank with water (not to exceed 60°C / 140°F) until the recovery tank is approximately half full.

WARNING: Flammable materials can cause an explosion or fire. Do not use flammable materials in tank(s).

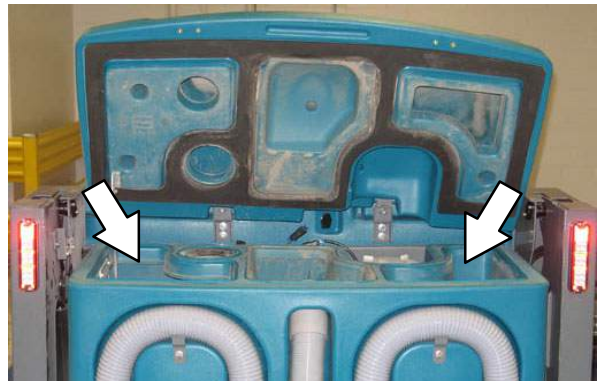

OPERATION

SETTING SCRUB MODES

Before scrubbing, determine which scrub mode will be used (FaST, ES, ec-H₂O or conventional). Then set the scrub brush pressure and adjust the solution flow levels. The machine will default to the last setting used when it is powered on or off.

SETTING ec-H₂O MODE

NOTE: Storage or transporting machines equipped with ec-H₂O in freezing temperatures requires special procedures. Follow the freeze protection procedure located in the STORAGE INFORMATION section.

Machines equipped with standard control panel: The ec-H₂O button enables the ec-H₂O system to come on when the 1-STEP button is activated. The light above the button will come on.

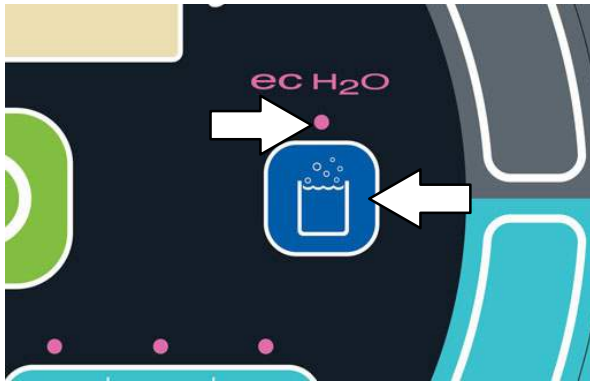

Standard Panel

A flashing red light located on the bottom portion of the LED (light-emitting diode) light directly above the ec-H₂O button indicates when the ec-H₂O system needs to be flushed. See ec-H₂O MODULE FLUSH PROCEDURE in the MAINTENANCE section

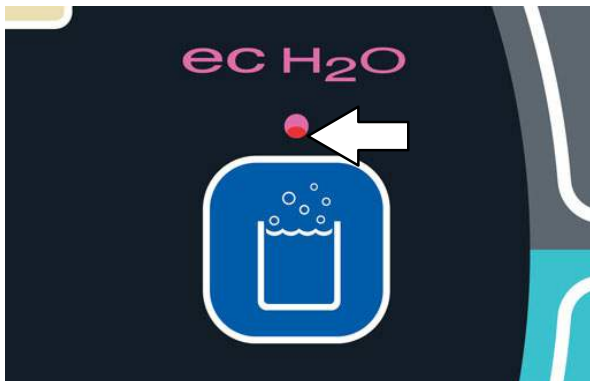

Standard Panel

Machines equipped with Pro-Panel controls:

The background will change from black to the multicolored background, the slash disappears from the ec-H₂O button, and the button is illuminated when the ec-H₂O button is pushed to indicate it is active.



Pro-Panel

The ec-H₂O button will turn red, the fault / alert indicator button will flash, and an ec-H₂O error message will appear in the display when there is an ec-H₂O error.

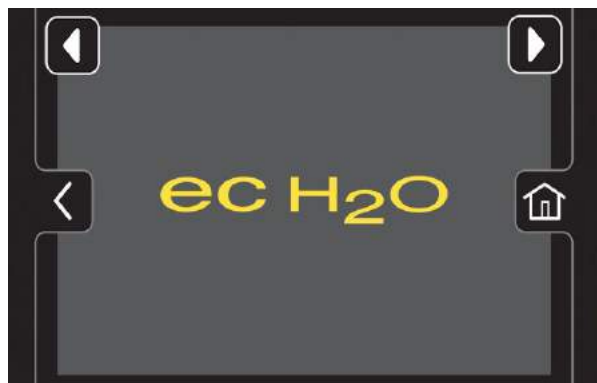

SETTING FaST MODE

Machines equipped with standard control panel: The *FaST* button enables the FaST system to come on when the 1-STEP button is activated. The light next to the button will come on.

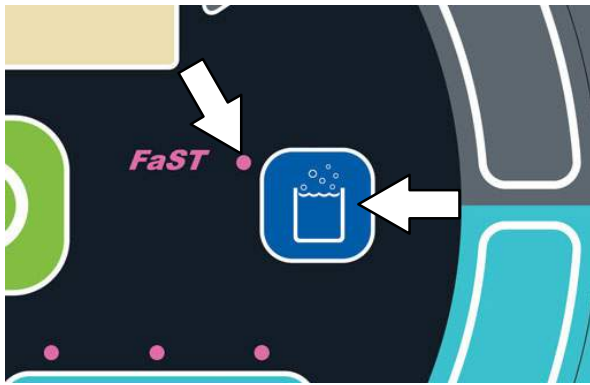

Standard Panel

Machines equipped with Pro-Panel controls: The slash disappears from the *FaST* button and the button is illuminated when the *FaST* button is pushed to indicate it is active.

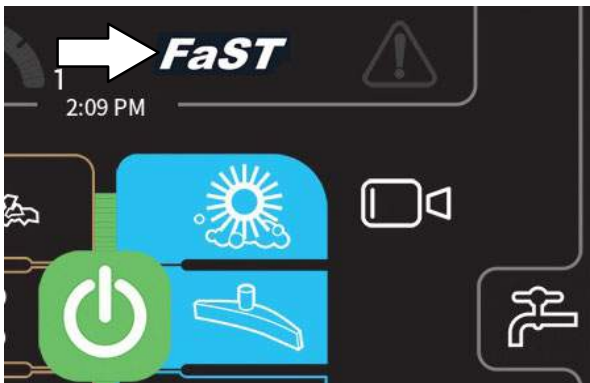
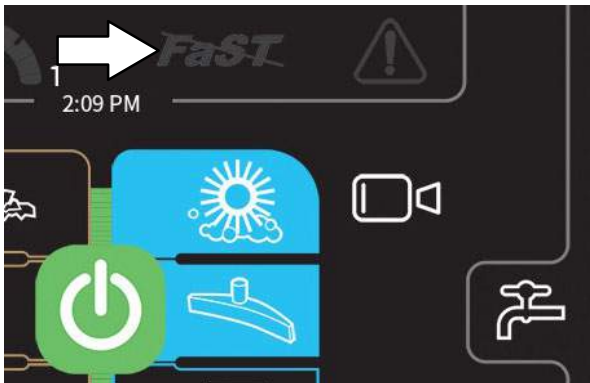

Pro-Panel

SETTING ES (EXTENDED SCRUB) MODE

NOTE: When the ES system is turned on there is a slight delay before the ES pump begins operating.

Machines equipped with standard control panel: The *ES* button enables the ES system to come on when the 1-STEP button is activated. The light next to the button will come on.

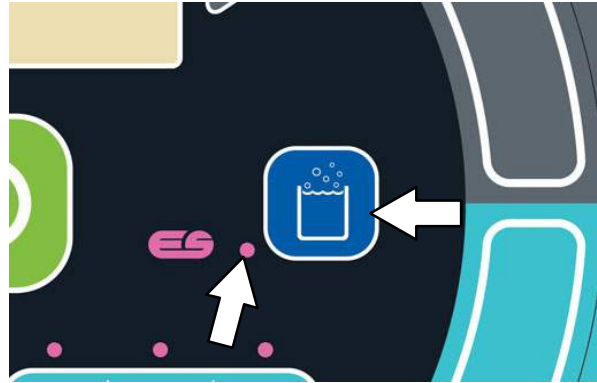

Standard Panel

Machines equipped with Pro-Panel controls: The slash disappears from the *ES* button and the button is illuminated when the *ES* button is pushed to indicate it is active.



Pro-Panel

OPERATION

SETTING BRUSH PRESSURE

Under normal cleaning conditions, the brush pressure should be set to the lowest setting. Under heavy grime conditions, the brush pressure can be set to a higher setting. Travel speed and floor conditions will affect cleaning performance. If brushes are worn, it may be necessary to increase the brush pressure. The machine will default to the last setting used when it is powered on or off.

SETTING BRUSH PRESSURE – STANDARD PANEL

With the *1-STEP* button activated, press the *brush pressure* button to both raise or lower the brush pressure settings. The brush pressure indicator lights display the current brush pressure setting.



SETTING BRUSH PRESSURE – PRO-PANEL

Press the *brush pressure* button to access the *brush pressure increase (+)* button, the *brush pressure decrease (-)* button, and the *brush pressure indicator bar*.



Use the *brush pressure increase (+)* button and the *brush pressure decrease (-)* button to change the brush pressure. The *brush pressure indicator bar* displays the current brush pressure setting.

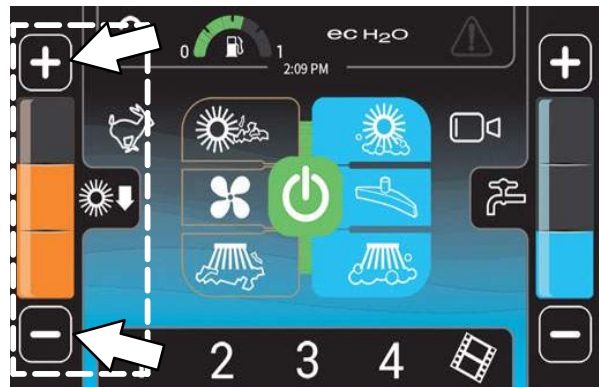

SETTING SOLUTION FLOW

Travel speed and floor conditions will affect scrubbing performance. Under normal soilage conditions the solution flow level should be set to the lowest setting. Under heavy grime conditions, the solution flow level should be set to the higher settings. The machine will default to the last setting used when the machine is powered on or off.

ES (EXTENDED SCRUB) SOLUTION FLOW

For ES machines, the detergent flow is turned off when the solution flow is in the lowest setting. Under normal soilage conditions, the solution flow level should be alternated between the middle and lowest setting. The middle setting allows solution AND detergent flow. The lowest setting allows solution flow WITHOUT adding detergent. Detergent does not have to be continuously added with the solution flow to attain effective scrubbing results.

SETTING SOLUTION FLOW – STANDARD PANEL

With the 1-STEP button activated, press either solution increase (+) button or solution decrease (-) button to set the solution flow level. The solution flow indicator lights display the current solution flow setting.

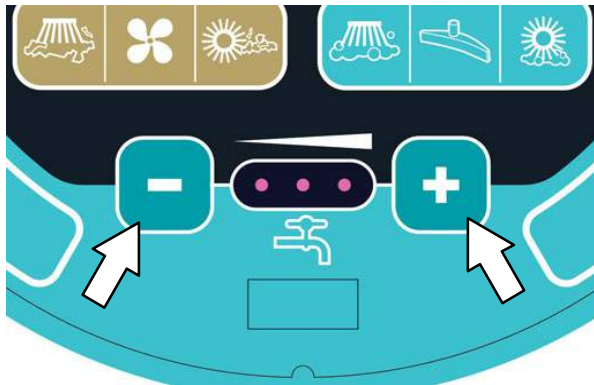

SETTING SOLUTION FLOW – PRO-PANEL

Press the *solution flow* button to access the *solution increase (+) button*, the *solution decrease (-) button*, and the *solution flow indicator bar*.



Use the *solution increase (+) button* and the *solution decrease (-) button* to set the solution flow level. The *solution flow indicator bar* displays the current solution flow setting.

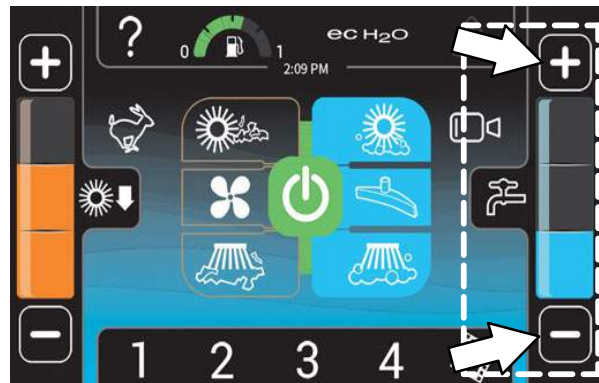

OPERATION

SCRUBBING – STANDARD PANEL

The **1-STEP button** operates all the scrubbing functions. (The machine also wet sweeps while scrubbing).

FOR SAFETY: Do not operate machine, unless operator manual is read and understood.

1. Start the machine.

NOTE: Make sure the scrubbing modes / settings are set before scrubbing.

2. Press the **1-STEP button**. The light above the button will come on. All the preset scrubbing functions will turn on.

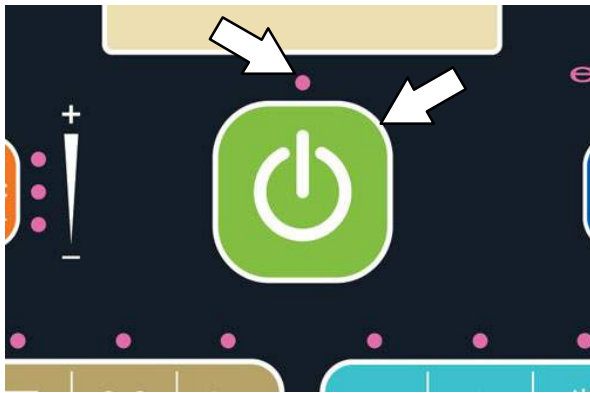

NOTE: DO NOT turn on the FaST or ec-H2O system during conventional scrubbing. Conventional cleaning detergents could cause a FaST or ec-H2O system failure. Drain, rinse, and refill the solution tank with cool clean water before operating the FaST or ec-H2O system.

3. Release the parking brake, then press the **Directional pedal** to begin scrubbing.

WARNING: Flammable materials or reactive metals can cause an explosion or fire. Do not pick up.

FOR SAFETY: When using machine, go slow on inclines and slippery surfaces.

NOTE: The squeegee automatically rises when the machine is driven backwards. This prevents damaging the squeegee.

4. Release the **directional pedal** and press the **brake pedal** to stop the machine.
5. Press the **1-STEP button** to stop scrubbing. The light above the button will go off and the scrubbing functions will stop after a short delay.

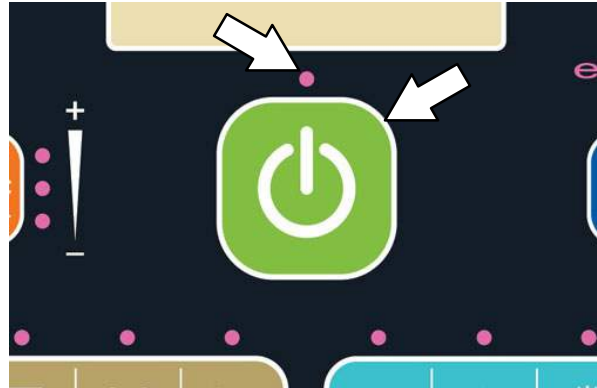

NOTE: If the machine was using the sweeping functions, the filter shaker automatically shakes the filter for a short time each time the 1-STEP button is turned off.

*NOTE: If there is a fault or alert code during machine operation, stop the machine and refer to the **FAULTS / ALERTS** section of this manual for the cause and the corrective action for eliminating the fault or alert.*

6. Empty the debris hopper and recovery tank at the end of each shift or as needed. See **EMPTYING THE HOPPER** and **DRAINING AND CLEANING THE RECOVERY TANK** sections of this manual.

SCRUBBING – PRO-PANEL

The 1-STEP button operates all the scrubbing functions. (The machine also wet sweeps while scrubbing).

FOR SAFETY: Do not operate machine, unless operator manual is read and understood.

1. Start the machine.
2. If applicable, log into the machine. See *PRO-ID LOGIN SCREEN*.
3. If applicable, complete the Pro-Check Pre-Operation Checklist. See *COMPLETING THE PRO-CHECK PRE-OPERATION CHECKLIST*.

NOTE: Make sure the scrubbing modes / settings are set before scrubbing.

4. Press the 1-STEP button. The light above the button will come on. All the preset sweeping functions will turn on.

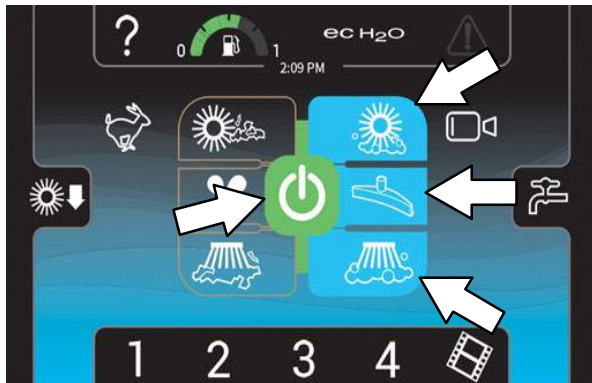

NOTE: DO NOT turn on the FaST or ec-H2O system during conventional scrubbing. Conventional cleaning detergents could cause a FaST or ec-H2O system failure. Drain, rinse, and refill the solution tank with cool clean water before operating the FaST or ec-H2O system.

5. Release the parking brake, then press the *Directional pedal* to begin scrubbing.

WARNING: Flammable materials or reactive metals can cause an explosion or fire. Do not pick up.

FOR SAFETY: When using machine, go slow on inclines and slippery surfaces.

NOTE: The squeegee automatically rises when the machine is driven backwards. This prevents damaging the squeegee.

6. Press the *rearview camera button* at any time to check cleaning performance behind the machine.



7. Release the *directional pedal* and press the *brake pedal* to stop the machine.
8. Press the 1-STEP button to stop scrubbing. The button will no longer be illuminated and scrubbing / sweeping functions will stop after a short delay.

NOTE: If the machine was using the sweeping functions, the filter shaker automatically shakes the filter for a short time each time the 1-STEP button is turned off.

*NOTE: If there is a fault or alert code during machine operation, stop the machine and refer to the **FAULTS / ALERTS** section of this manual for the cause and the corrective action for eliminating the fault or alert.*

9. Empty the debris hopper and recovery tank at the end of each shift or as needed. See *EMPTYING THE HOPPER* and *DRAINING AND CLEANING THE RECOVERY TANK* sections of this manual.

OPERATION

DOUBLE SCRUBBING

Double scrubbing is the process of making two or more passes over a heavily soiled area. The first pass is made with the rear and side squeegees raised to allow the solution to soak into the floor. Use the double scrubbing method to clean heavily soiled areas.

Double scrubbing can be performed using the FaST SCRUBBING SYSTEM (option), ec-H₂O SCRUBBING SYSTEM (option) or CONVENTIONAL SCRUBBING methods.

Before double scrubbing, remove the side brush bumper. Pull the pins and remove the squeegee bumper.

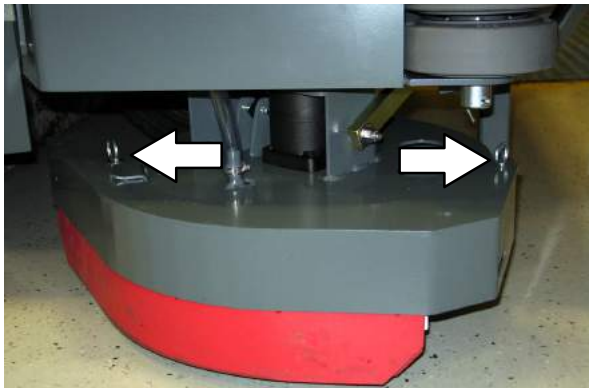

NOTE: Make sure the scrubbing modes / settings are set before scrubbing.

Machines equipped with standard panel:

Press the 1-STEP button, and then the Scrub vacuum fan/squeegee button. The light above the Scrub vacuum fan/squeegee button will turn off, the squeegee will rise, and the vacuum fan will stop operating. Scrub the heavily soiled area.

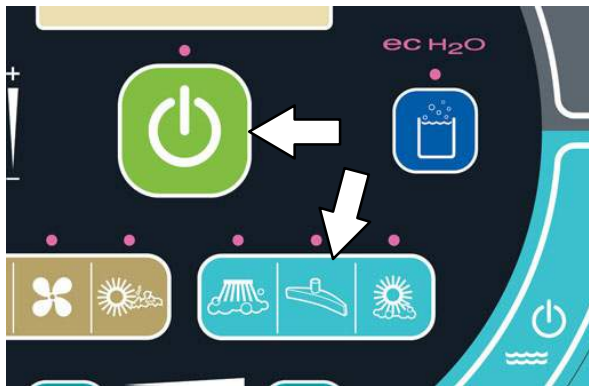

Standard Panel

NOTE: Make sure the scrubbing modes / settings are set before scrubbing.

Machines equipped with Pro-Panel: Press the 1-STEP button and then the vacuum fan / squeegee button. The vacuum fan / squeegee button will no longer be illuminated, the squeegee will rise, and the vacuum fan will stop operating. Scrub the heavily soiled area.



Pro-Panel

Let the cleaning solution soak on the floor for 5-15 minutes. Reinstall the side brush squeegee bumper onto the side brush.

FOR SAFETY: When using machine, go slow on inclines and slippery surfaces.

Press the Scrub vacuum fan/squeegee button again to lower the squeegee and turn on the vacuum fan. Scrub the floor a second time to pick up the cleaning solution.

WARNING: Flammable materials or reactive metals can cause an explosion or fire. Do not pick up.

NOTE: If needed, reduce solution flow when scrubbing the floor for a second time.

NOTE: Double scrubbing is not recommended in areas where the cleaning solution will run under racks or damage products.

WATER PICKUP MODE (NO SCRUBBING)

The machine can be used to pick up water or non-flammable liquid spills without scrubbing.

WARNING: Flammable materials or reactive metals can cause an explosion or fire. Do not pick up.

Before picking up water or non-flammable liquid spills, make sure the *1-STEP* button is activated and all other cleaning functions are off.

Machines equipped with standard control panel: Press the *scrubbing vacuum fan / squeegee* button. The light above the button will illuminate, the squeegee will lower, and the vacuum fan will start operating. Pick up the water or non-flammable liquid spill.

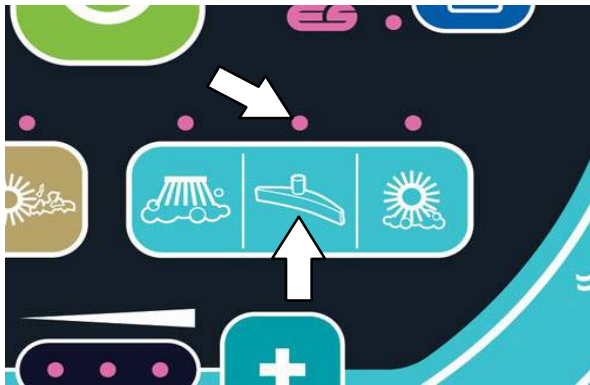

Standard Panel

Machines equipped with Pro-Panel controls: Press the *scrubbing vacuum fan / squeegee* button. The button will illuminate, the squeegee will lower, and the vacuum fan will start operating. Pick up the water or non-flammable liquid spill.



Pro-Panel

OPERATION

SWEEPING – STANDARD PANEL

NOTE: The 1-STEP button operates all the sweeping functions (without scrubbing).

FOR SAFETY: Do not operate machine, unless operator manual is read and understood.

Side brush option: Before sweeping, remove the side brush bumper. Pull the pins and remove the squeegee bumper.

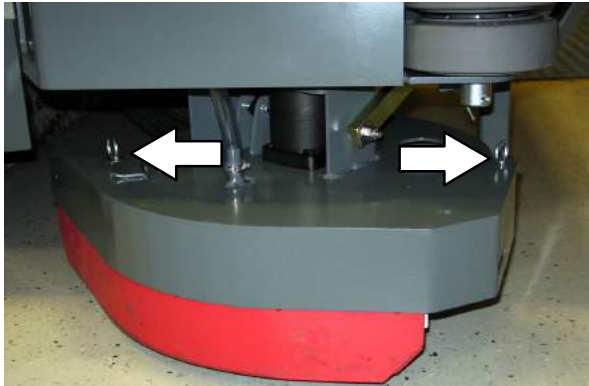

1. Start the machine.

NOTE: Make sure the sweeping modes / settings are set before sweeping.

2. Press the 1-STEP button. The light above the button will come on. All the preset sweeping functions will turn on.

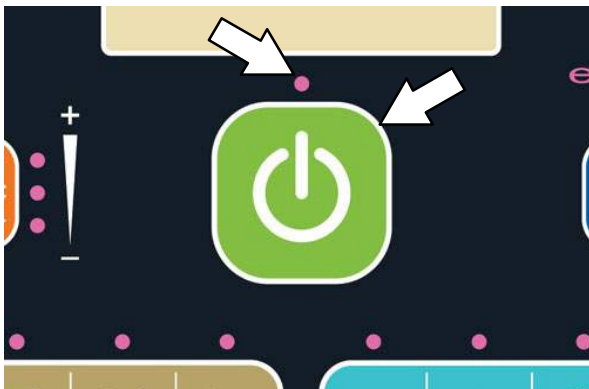

3. Release the parking brake, then press the Directional pedal to begin sweeping.

WARNING: Flammable materials or reactive metals can cause an explosion or fire. Do not pick up.

FOR SAFETY: When using machine, go slow on inclines and slippery surfaces.

NOTE: Press the sweep vacuum fan button to turn off the vacuum fan when sweeping over large wet areas or standing water. This prevents the hopper dust filter from getting wet while sweeping.

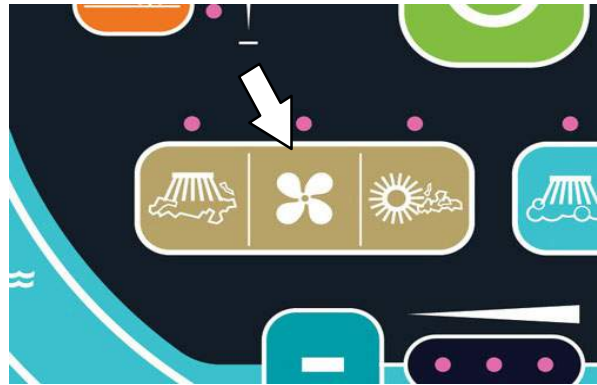

4. Release the directional pedal and press the brake pedal to stop the machine.
5. Press the 1-STEP button to stop sweeping. The light near the button will go off and the sweeping functions will stop after a short delay.



NOTE: If the machine was using the sweeping functions, the filter shaker automatically shakes the filter for a short time each time the 1-STEP button is turned off.

NOTE: If there is a fault or alert code during machine operation, stop the machine and refer to the FAULTS / ALERTS section of this manual for the cause and the corrective action for eliminating the fault or alert.

6. Empty the debris hopper and recovery tank at the end of each shift or as needed. See EMPTYING THE HOPPER and DRAINING AND CLEANING THE RECOVERY TANK sections of this manual.

SWEEPING – PRO-PANEL

NOTE: The 1-STEP button operates all the sweeping functions (without scrubbing).

FOR SAFETY: Do not operate machine, unless operator manual is read and understood.

Side brush option: Before sweeping, remove the side brush bumper. Pull the pins and remove the squeegee bumper.

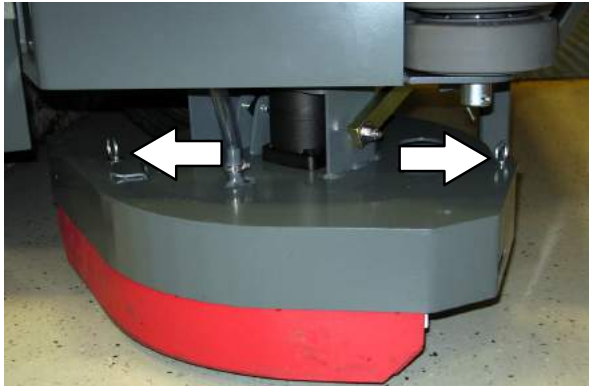

1. Start the machine.
2. If applicable, log into the machine. See *PRO-ID LOGIN SCREEN*.
3. If applicable, complete the Pro-Check Pre-Operation Checklist. See *COMPLETING THE PRO-CHECK PRE-OPERATION CHECKLIST*.

NOTE: Make sure the sweeping modes / settings are set before sweeping.

4. Press the 1-STEP button. The 1-STEP button and all other selected sweeping buttons will illuminate.

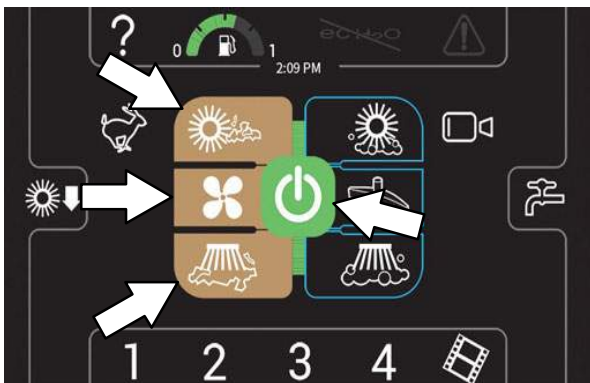

5. Release the parking brake, then press the *Directional pedal* to begin sweeping.

WARNING: Flammable materials or reactive metals can cause an explosion or fire. Do not pick up.

FOR SAFETY: When using machine, go slow on inclines and slippery surfaces.

NOTE: Press the sweep vacuum fan button to turn off the vacuum fan when sweeping over large wet areas or standing water. This prevents the hopper dust filter from getting wet while sweeping.

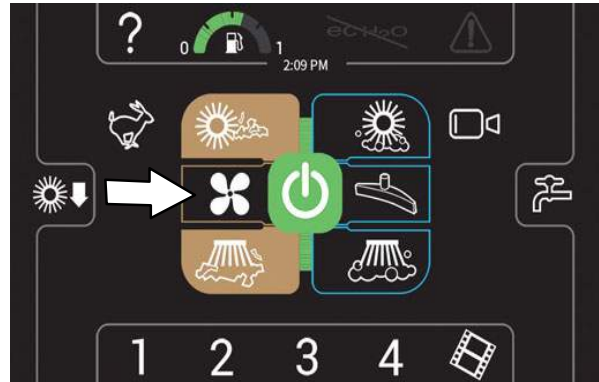

6. Press the *rearview camera button* at any time to check cleaning performance behind the machine.



7. Release the *directional pedal* and press the *brake pedal* to stop the machine.
8. Press the 1-STEP button to stop sweeping. The button will no longer be illuminated and sweeping functions will stop after a short delay.

NOTE: If the machine was using the sweeping functions, the filter shaker automatically shakes the filter for a short time each time the 1-STEP button is turned off.

*NOTE: If there is a fault or alert code during machine operation, stop the machine and refer to the **FAULTS / ALERTS** section of this manual for the cause and the corrective action for eliminating the fault or alert.*

9. Empty the debris hopper and recovery tank at the end of each shift or as needed. See *EMPTYING THE HOPPER* and *DRAINING AND CLEANING THE RECOVERY TANK* sections of this manual.

OPERATION

EMPTYING THE HOPPER

1. Drive the machine to a debris site or container.
2. Press the *Filter shaker switch*. The shaker operates for approximately 30 seconds. The indicator light comes on while the filter shaker is operating.



3. After the filter shaker stops, press and hold the top of the *Hopper raise/lower switch* to raise the hopper. Release the switch when the hopper is at the desired position.

FOR SAFETY: When using machine, make sure adequate clearance is available before raising hopper. Do not raise hopper when machine is on an incline.

NOTE: Be aware the minimum ceiling height needed to raise the hopper is 2500 mm (98 in).



4. Slowly back the machine up to the debris container.

FOR SAFETY: When using machine, use care when reversing machine. Move machine with care when hopper is raised.

5. Press and hold the bottom of the *Hopper door open/close switch* to open the hopper door and empty the contents from the hopper.



6. Slowly drive the machine forward away from the debris site or container.
7. Stop the machine, then press and hold the bottom of the *Hopper raise/lower switch* until the hopper is completely lowered.

NOTE: The hopper door will close automatically when the hopper is lowered. The hopper door can be closed by pressing the top of the hopper door open/close switch.

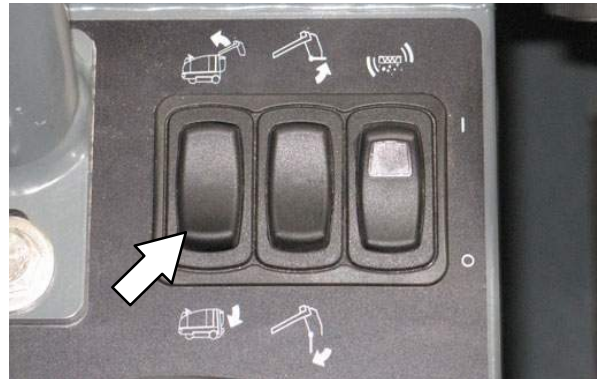

ENGAGING HOPPER SUPPORT PIN

The hopper support pin is a safety feature used to prevent the raised hopper from falling. Always use the hopper support pin whenever leaving the hopper in a raised position.

1. Stop the machine.
2. Press and hold the top of the *Hopper raise/lower switch* to raise the hopper. Release the switch when the hopper is at the desired position.

WARNING: Lift arm pinch point. Stay clear of hopper lift arms.

FOR SAFETY: When using machine, make sure adequate clearance is available before raising hopper.



3. Set the parking brake.
4. Remove the hopper support pin from the storage tube.

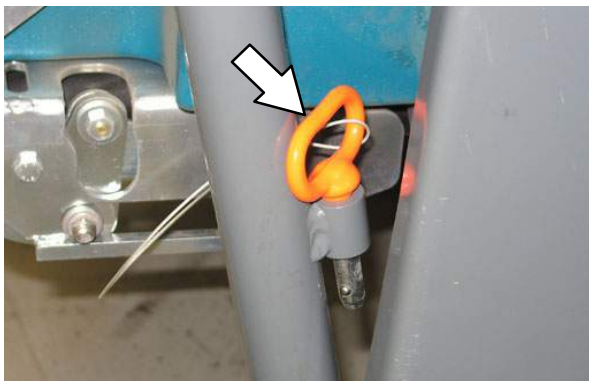

5. Insert the hopper support pin into one of the three hopper support holes. Lower the hopper until it rests on the support pin.

WARNING: Raised hopper may fall. Engage hopper support pin.

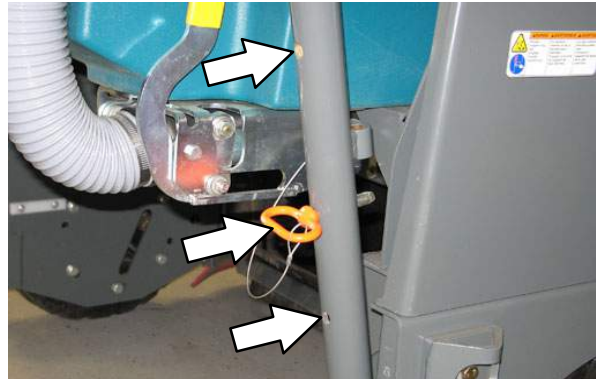

DISENGAGING HOPPER SUPPORT PIN

1. Set the parking brake.
2. Press and hold the top of the *Hopper raise/lower switch* until the hopper is off the support pin.
3. Remove the hopper support pin from the hopper support hole and insert it into the storage tube.
4. Sit in the operators seat, then press and hold the bottom of the *Hopper raise/lower switch* until the hopper is completely lowered.



WARNING: Lift arm pinch point. Stay clear of hopper lift arms.

OPERATION

REMOVING THE HOPPER DUST FILTER

NOTE: Empty hopper before removing the hopper dust filter.

1. Raise the hopper to the middle support position and engage the hopper support pin. See *ENGAGING HOPPER SUPPORT PIN* section of this manual.

NOTE: Do NOT raise the hopper to the top support position when accessing the dust filter.

WARNING: Raised hopper may fall. Engage hopper support pin.

WARNING: Lift arm pinch point. Stay clear of hopper lift arms.

2. Turn off the machine.

FOR SAFETY: Before leaving or servicing machine, stop on level surface, set parking brake, turn off machine, and remove key.

3. Loosen the hose clamp on the squeegee vacuum hose.
4. Disconnect the squeegee vacuum hose from the hopper.



5. Unhook the handles from the filter cover.

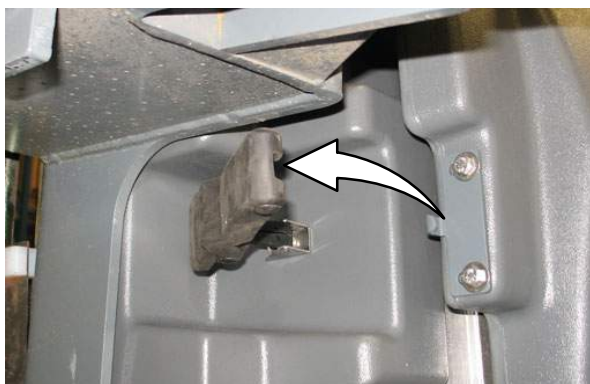

6. Open the filter cover and rest it against the machine.

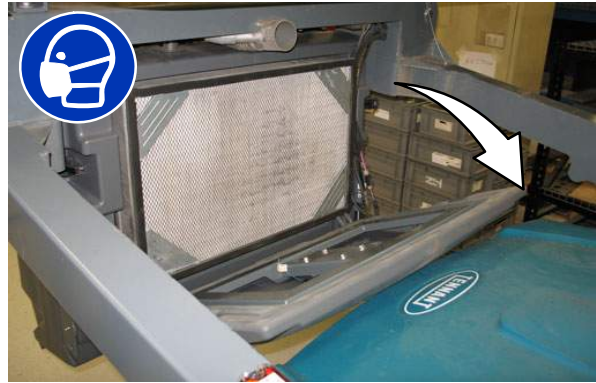

7. Remove the dust filter and perma-filter tray from the hopper.

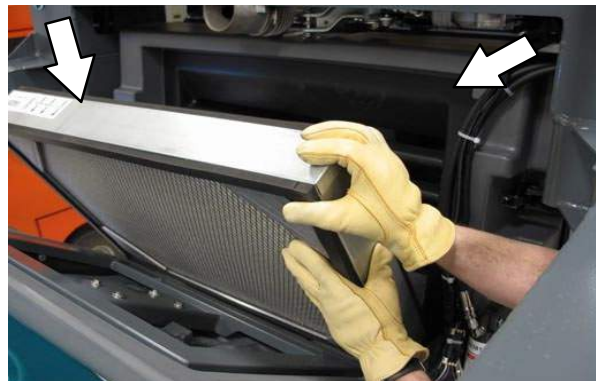

8. Clean or discard the dust filter. See the *CLEANING THE HOPPER DUST FILTER* section of this manual.
9. Place the perma-filter tray into the hopper.
10. Place the cleaned or new dust filter into the hopper. Position the filter screen side up as shown below.



11. Close the filter cover and secure the filter cover to the hopper with the handles.
12. Reconnect the squeegee vacuum hose to the hopper.
13. Disengage the hopper support pin and lower the hopper. See the *DISENGAGING HOPPER SUPPORT PIN* section of this manual.

CLEANING THE HOPPER AND DEBRIS SCREEN

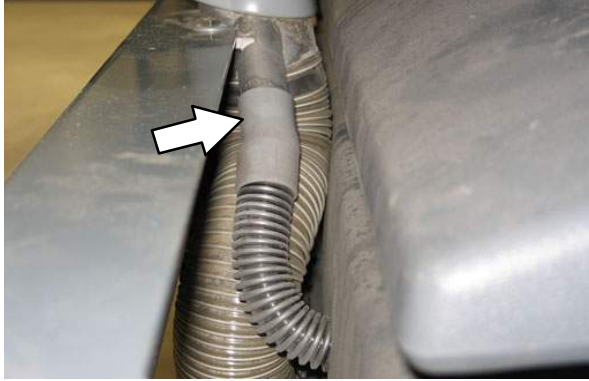

FOR SAFETY: Before leaving or servicing machine, stop on level surface, and set parking brake.

1. Disconnect the vacuum hose from the debris screen.

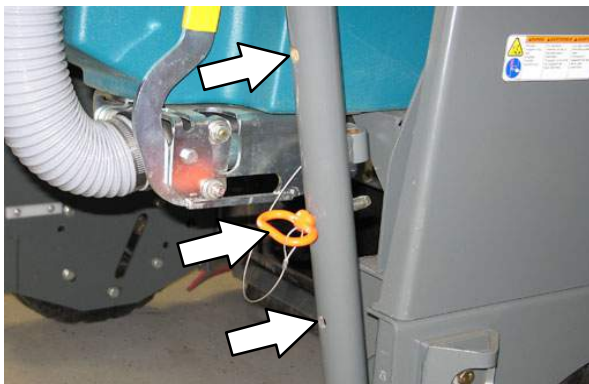

2. Raise the hopper to the middle support position and engage the hopper support pin. See *ENGAGING HOPPER SUPPORT PIN* section of this manual.



-  **WARNING:** Raised hopper may fall. Engage hopper support pin.
-  **WARNING:** Lift arm pinch point. Stay clear of hopper lift arms.

3. Turn off the machine.
4. Remove the filter from the hopper. See the *REMOVING THE HOPPER DUST FILTER* section of this manual.

NOTE: Do NOT raise the hopper to the top support position when accessing the dust filter.

5. Start the machine.

6. Press and hold the bottom of the *hopper door open / close switch* until the hopper door is completely open.



7. Turn off the machine.
8. Flush dirt and debris from the debris hose and debris screen and out into the hopper.

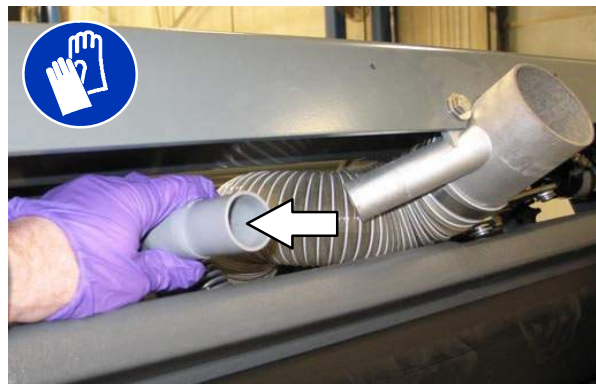

9. Rinse dirt and debris from the debris screen and the hopper. If necessary, remove the debris screen to clean.



10. Reinstall the hopper dust filter. See *REMOVING THE HOPPER DUST FILTER* section of this manual.
11. Disengage the hopper support pin and lower the hopper. See the *DISENGAGING HOPPER SUPPORT PIN* section of this manual.

OPERATION

DRAINING AND CLEANING THE RECOVERY TANK

Drain and clean the recovery tank daily or when the recovery tank full indicator comes on.

Clean the outside of the recovery tank with vinyl cleaner.

FOR SAFETY: Before leaving or servicing machine, stop on level surface, set parking brake, turn off machine, and remove key.

DRAINING THE RECOVERY TANK WITH THE DRAIN HOSE

1. Lift the recovery tank cover.



2. Place the recovery tank drain hose nozzle next to a floor drain.

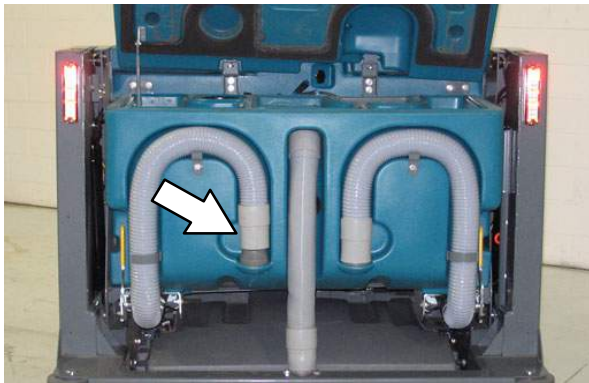

3. Open the recovery tank Variable Drain Valve.

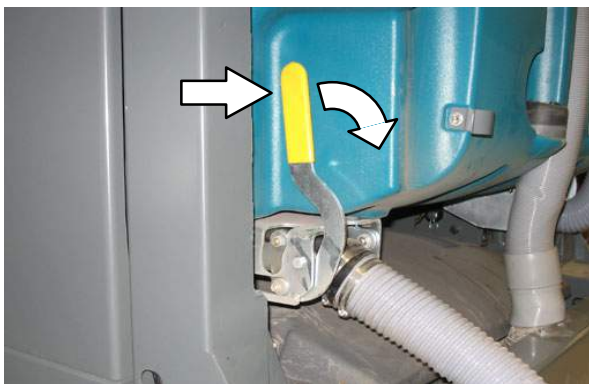

4. Rinse dirt and debris down through the drain hole in the demister tray and flush the vacuum hose.

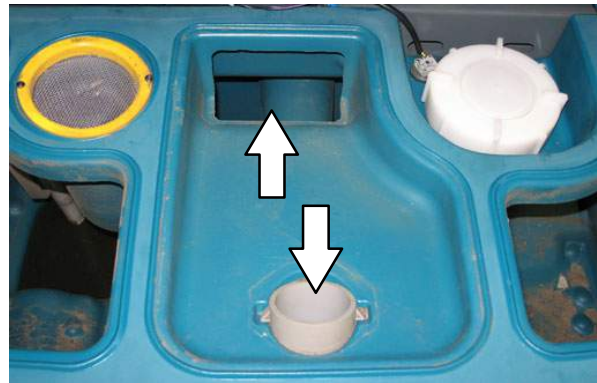

NOTE: DO NOT use steam to clean tanks. Excessive heat can damage tanks and components.

5. Remove the vacuum screen from the recovery tank and rinse the screen.



6. Rinse the float sensor.



- ES machines: Rinse the ES filter. If necessary, remove the ES filter from the recovery tank.

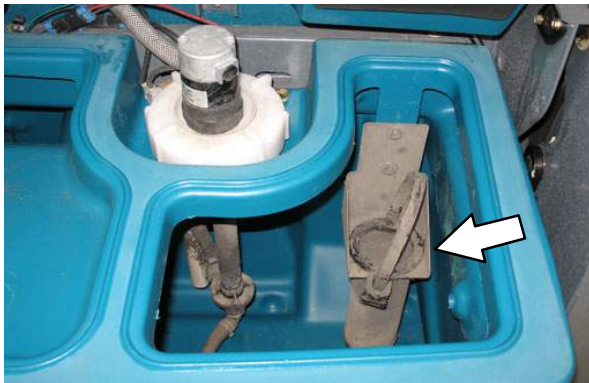

- Rinse dirt and debris towards the recovery tank drain. Allow the recovery tank to drain.

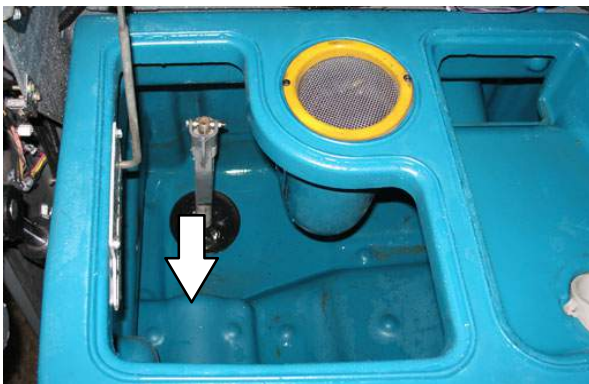

- Close the recovery tank Variable Drain Valve.

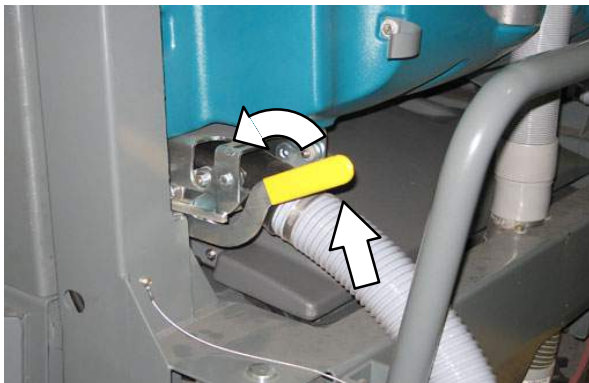

- Reinstall the recovery tank drain hose onto the back of the recovery tank and close the recovery tank cover.

DRAINING THE RECOVERY TANK WITH THE DRAIN PLUG

Use the drain plug to drain the recovery tank if the tank is draining slowly or if the drain hose is plugged.

- Park the machine so the larger drain in the recovery tank is positioned over the disposal drain. Set the parking brake.

- To avoid getting the hopper filter wet, raise the hopper and engage the hopper support pin in the lowest position.

WARNING: Raised hopper may fall. Engage hopper support pin.

WARNING: Lift arm pinch point. Stay clear of hopper lift arms.



FOR SAFETY: Before leaving or servicing machine, stop on level surface, set parking brake, turn off machine, and remove key.

- Lift the drain plug handle and remove the drain plug from the tank.

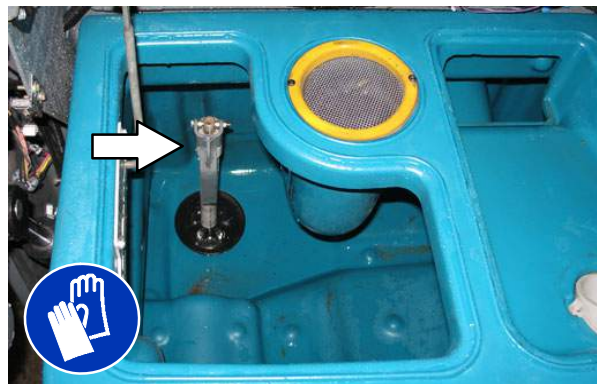

- Open the recovery tank Variable Drain Valve.

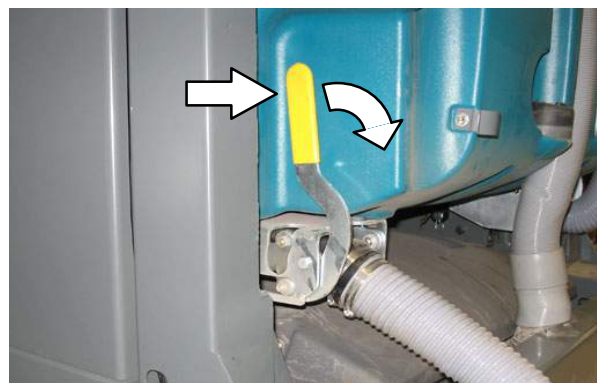

OPERATION

5. Remove the recovery tank drain hose from the back of the recovery tank, then rinse the dirt and debris from the hose into the tank.



6. Rinse dirt and debris out the open drain.

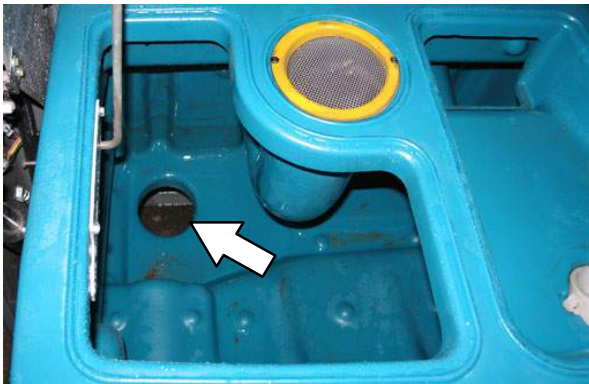

7. Clean the drain hole, then reinsert the drain plug. Push the handle down to tighten. Be sure the drain plug is fully seated before tightening.

NOTE: If necessary, turn the handle clockwise for a tighter fit and counterclockwise for a looser fit.



8. Close the recovery tank Variable Drain Valve.

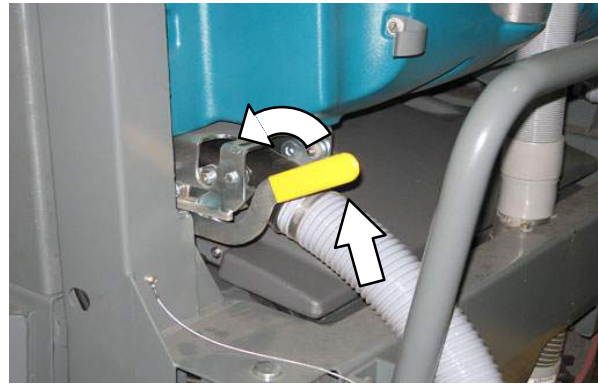

9. Reinstall the recovery tank drain hose onto the back of the recovery tank.
10. Remove the hopper support pin and insert it into the storage tube. Then lower the hopper.
11. Close the recovery tank cover.

DRAINING AND CLEANING THE SOLUTION TANK

The solution tank on non-ES machines does not require regular maintenance. If deposits form on the bottom of the tank, rinse the tank with a strong blast of warm water.

Clean the outside of the solution tank with vinyl cleaner.

The solution tank on machines with the ES option should be drained and cleaned daily.

FOR SAFETY: Before leaving or servicing machine, stop on level surface, set parking brake, turn off machine, and remove key.

1. Open the solution tank cover(s).



2. Place the solution tank drain hose nozzle next to a floor drain.

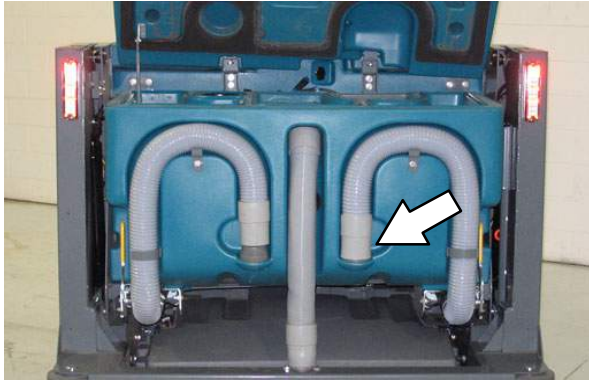

3. Open the solution tank Variable Drain Valve.

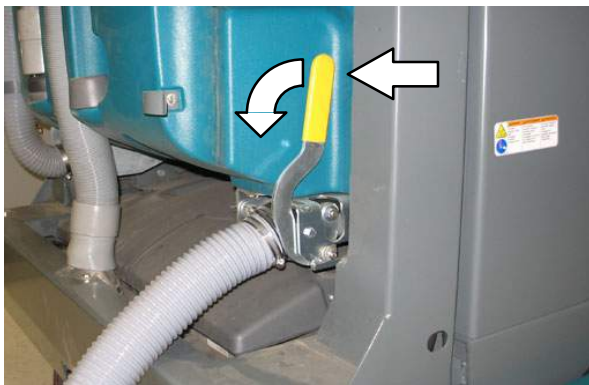

4. Rinse the solution tank. Flush dirt and debris toward the solution tank drain.

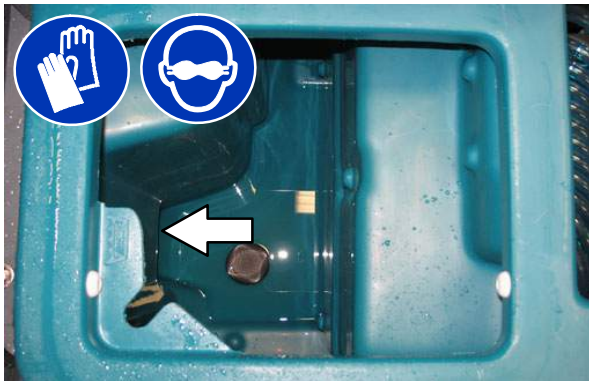

5. Rinse the float sensor and the screen filter. Allow the solution tank to drain.

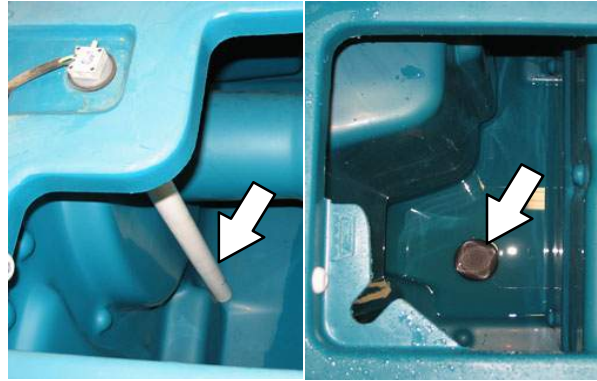

6. Close the solution tank Variable Drain Valve.

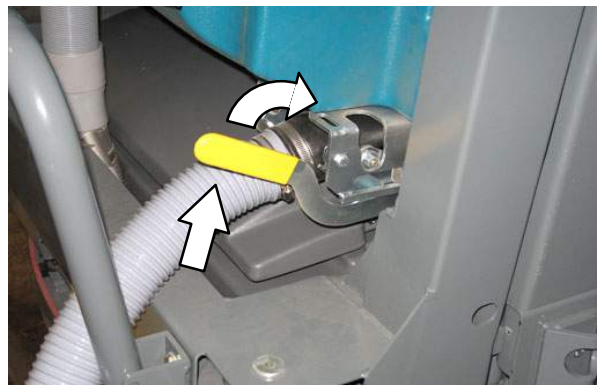

7. Reinstall the solution tank drain hose onto the back of the recovery tank.

8. Close the solution tank cover(s).

OPERATION

FAULTS / ALERTS

The operator will receive a fault / alert warning when there is a mechanical / electronic issue with the machine.

To reset the fault / alert indicators, turn off the machine and then eliminate the cause of the fault / alert. The fault / alert indicator will reset when the machine is restarted.

Refer to the fault / alert indicators table to determine the cause and remedy for the fault / alert.

NOTE: When the machine is turned on without the engine running, the low engine oil pressure, low alternator voltage and check engine lamp faults will appear. This is normal behavior.

FAULT / ALERT INDICATORS – STANDARD PANEL

This machine is equipped with two visual indicators, a red indicator light and an LCD (liquid crystal display).

The red indicator light will blink continuously indicating that a fault / alert has occurred.

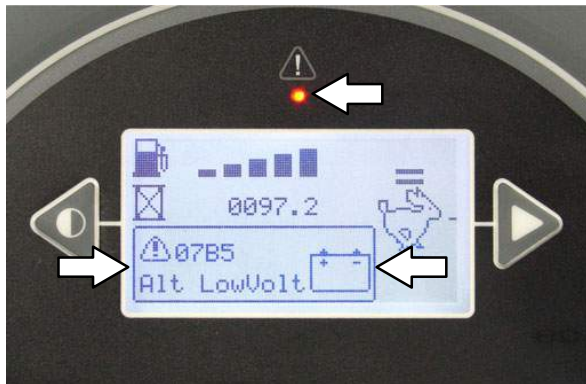



The LCD will display a fault / alert code. If there is more than one fault, each fault code will alternately display.

FAULT / ALERT INDICATORS – PRO-PANEL

The *fault / alert indicator button* will flash continuously indicating a fault / alert has occurred. The multicolored background will change to a black background.





 Press the flashing *red fault indicator button* to view the faults. A fault / alert screen will appear in the display.

 Press the flashing *yellow alert indicator button* to view the alerts. A fault / alert screen will appear in the display.

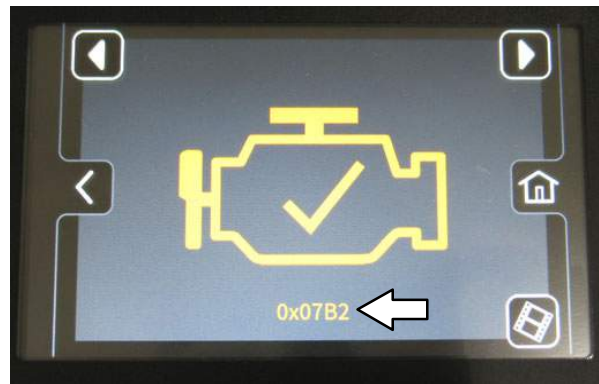
Fault / alert text will appear under the icon in the center of the screen



 Press *right arrow button* to scroll forward through the faults / alerts.

 Press *left arrow button* to scroll back through the faults / alerts.

 Press the *home button* to return to the main operating screen.

 Press the *back button* to return to the previous screen.

Fault Code Number	Fault Code Standard Panel	Fault Code Pro-Panel	Causes(s)	Remedy
0x0010	Fault Parking Brake	Fault Parking Brake	Parking brake engaged	Release parking brake
0x0701	Fault ECH2O Flush Needed	Fault ECH2O Flush Needed	ec-H2O system plugged with impurities	Flush ec-H2O system
0x0781	Fault Detergent Empty	Fault Detergent Empty	Detergent tank is empty	Fill detergent tank
0x0790	Fault Solution Tank Empty	Fault Solution Tank Empty	Solution tank is empty	Fill solution tank
0x0791	Fault Recovery Tank Full	Fault Recovery Tank Full	Recovery tank is full	Empty recovery tank
0x07A0	Fault Filter Clogged	Fault Filter Clogged	Hydraulic filter clogged	Shut off machine. Contact TENNANT service representative
0x07A1	Fault Hopper Fire	Fault Hopper Fire	Fire in the hopper	Shut off machine Extinguish fire If necessary, call emergency personnel
0x07A2	Fault Hopper Not Home	Fault Hopper Not Home	Hopper not completely lowered	Lower hopper completely
0x07A3	Fault Shaker Clogged	Fault Shaker Clogged	Filter shaker is clogged	Remove and clean / or replace hopper filter
0x07A4	Fault Seat Empty	Fault Seat Empty	Operator not in seat while engine is running	Operator must be in operator seat for machine to function
0x07B0	Fault Engine High Temp	Fault Engine High Temp	Engine overheating	Add coolant to coolant system
0x07B1	Fault Hydraulic High Temp	Fault Hydraulic High Temp	Hydraulic fluid temperature is high	Shut off machine. Contact TENNANT service representative
0x07B2	Fault Engine Malfunction Indicator	Fault Engine Malfunction Indicator	Engine malfunction	Shut off machine. Contact TENNANT service representative
0x07B3	Fault Low Fuel	Fault Low Fuel	Fuel tank near empty	Fill fuel tank (gasoline) Replace fuel tank (LPG)
0x07B4	Fault Engine Low Oil Pressure	Fault Engine Low Oil Pressure	Oil level possibly low	Add engine oil as needed
0x07B5	Fault Engine Alternator Low Voltage	Fault Engine Alternator Low Voltage	Inadequate voltage supply to engine	Shut off machine. Contact TENNANT service representative

**NOTE: Contact a Tennant Service representative for all other fault codes.*

OPERATION

OPTIONS

SPRAY NOZZLE (OPTION)

The spray nozzle is used to clean the machine and surrounding areas. The solution tank provides a water/solution supply for the spray nozzle. A wand is included with the spray nozzle.

NOTE: Do NOT get water on electronic components when using the spray nozzle to clean the machine.

FOR SAFETY: Before leaving or servicing machine, stop on level surface, set parking brake, and turn off machine.

1. Turn the key to the on position (without starting the machine).

NOTE: The spray nozzle can be operated while the engine is running, but it is recommended to turn the engine off while using the spray nozzle.

2. Press the top of the *Spray nozzle switch* to turn on the water supply. The light on the switch will come on when the spray nozzle is activated.



3. Remove the spray nozzle from the storage area and clean as required.

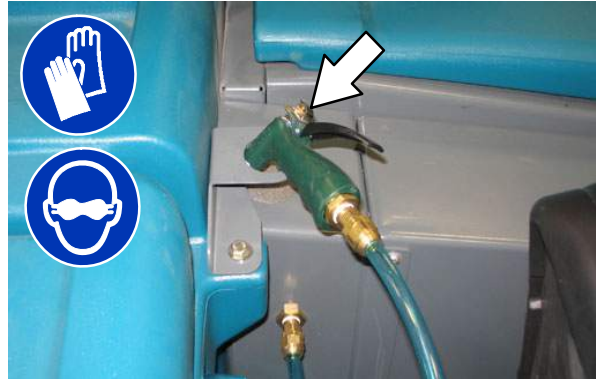

FOR SAFETY: When using pressurized air or water, wear eye protection.

4. If cleaning a hard to reach area, install the wand onto the spray nozzle.

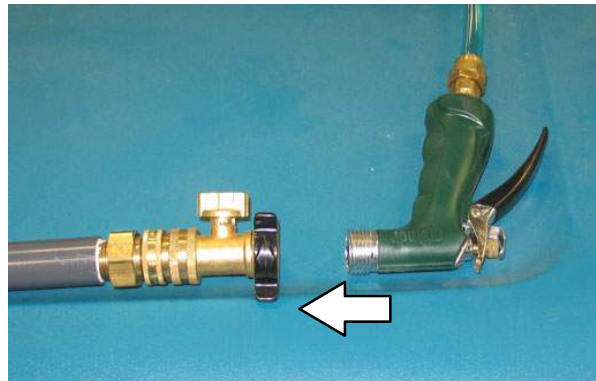

5. Twist the off/on knob to turn on the wand.

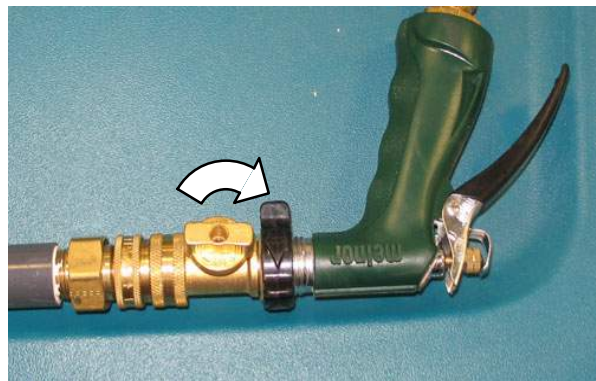

6. When finished cleaning, place the spray nozzle and wand back into their storage locations.

7. Press the bottom of the *Spray nozzle switch* to turn off the water supply.

VACUUM WAND (OPTION)

FOR SAFETY: Before leaving or servicing machine, stop on level surface, set parking brake, turn off machine, and remove key.

1. Remove the vacuum wand nozzle and hose from the storage bag.



2. Attach the wand hose to the vacuum hose.



3. Assemble the wand and nozzle.
4. Start the machine.

⚠️ WARNING: Engine emits toxic gases. Severe respiratory damage or asphyxiation can result. Provide adequate ventilation. Consult with your regulatory authorities for exposure limits. Keep engine properly tuned.

5. Verify that the *1-STEP* button is on.
6. Press the *vacuum fan / squeegee* button to turn on the vacuum fan.

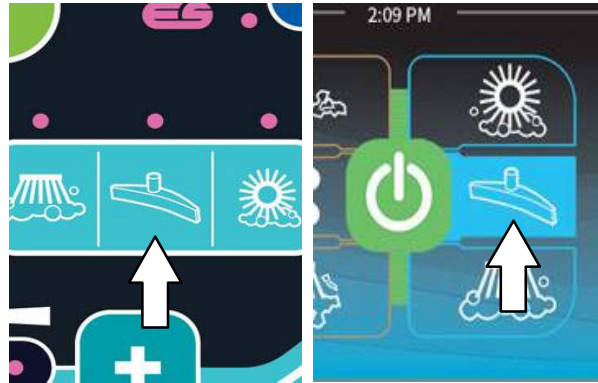

Standard Panel

Pro-Panel

NOTE: The squeegee will lower.

7. Clean the spill or debris.



8. When finished vacuuming, press the *Scrub vacuum fan/squeegee* button to turn off the vacuum. The light above the button will turn off.
9. Turn off the machine.
10. Disassemble the vacuum wand assembly and return it to the storage bag.
11. Reattach the vacuum hose to the hopper lift arm.

OPERATION

HIGH PRESSURE WASHER (OPTION)

The high pressure washer is used to clean the machine and surrounding areas.

NOTE: Do NOT get water on electronic components when using the high pressure washer to clean the machine.

FOR SAFETY: Before leaving or servicing machine, stop on level surface, set parking brake, and turn off machine.

FOR SAFETY: When using pressurized air or water, wear eye and ear protection.

1. Turn off the machine and set the parking brake.

NOTE: The high pressure washer will not operate unless the parking brake is set.

2. Open the front shroud.

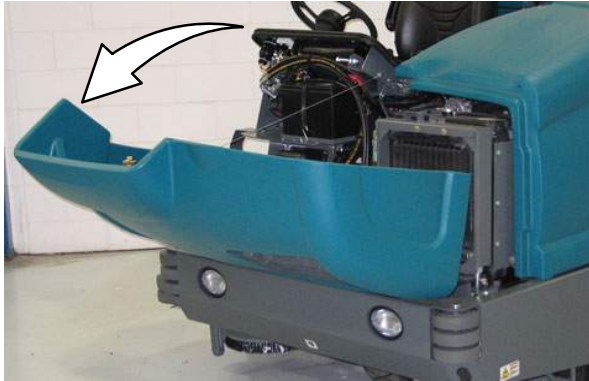

3. Connect the hose to the high pressure washer system.

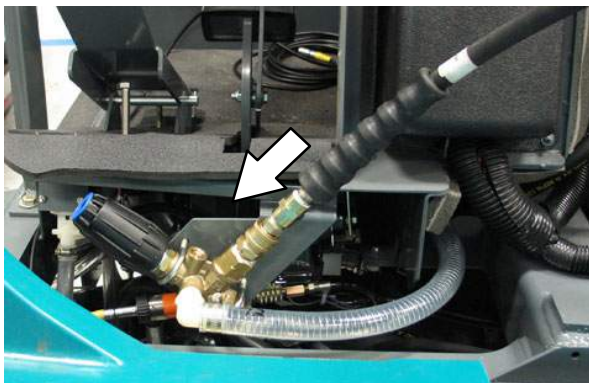

4. Connect the other end of the hose to the wand.

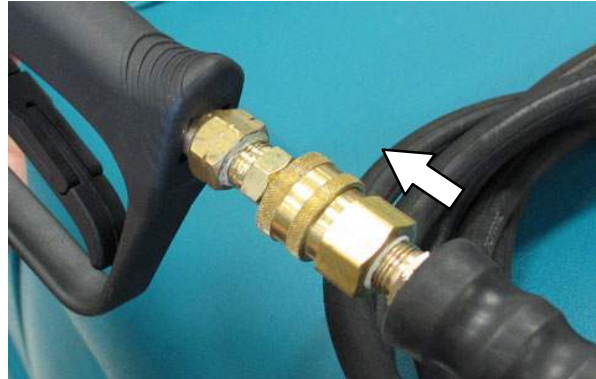

5. Adjust the nozzle on the wand to the desired setting.

Pull the nozzle out for the **Low** pressure setting, or push the nozzle in for the **High** pressure setting. Twist the nozzle for either the **Stream** or **Fan** setting.



6. Start the machine.

WARNING: Engine emits toxic gases. Severe respiratory damage or asphyxiation can result. Provide adequate ventilation. Consult with your regulatory authorities for exposure limits. Keep engine properly tuned.

7. Verify that the 1-STEP button is off.

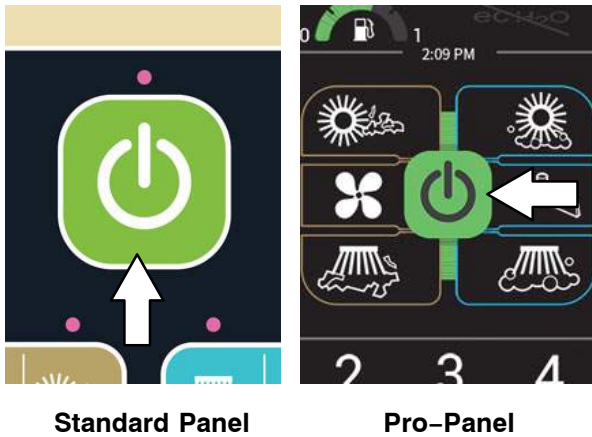

8. Press the engine speed button to increase the engine RPM.

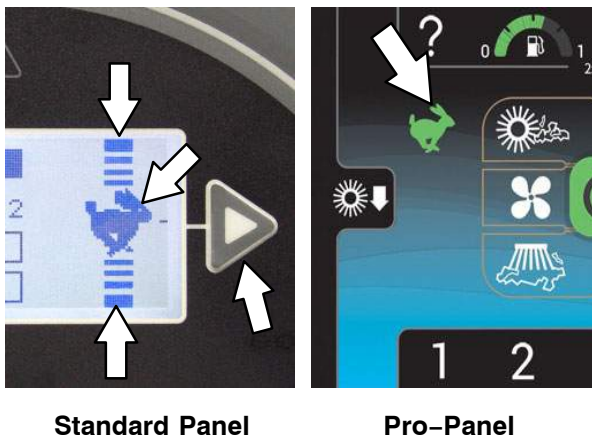

9. Press the top of the Pressure washer switch.



10. If necessary, adjust the pressure. Turn the knob clockwise to increase pressure and counterclockwise to decrease pressure.

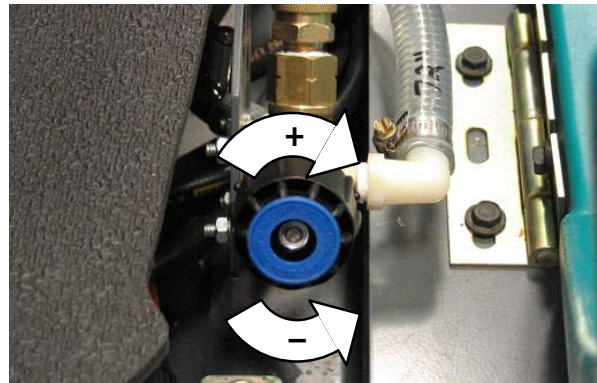

NOTE: Adjust the pressure at the wand before adjusting it at the system.

11. Squeeze the trigger to begin cleaning.

WARNING: Do not spray people or animals. Severe personal injury can result. Wear eye protection. Hold sprayer with two hands.



12. When finished cleaning, release the trigger.

13. Press the engine speed button to decrease the engine RPM.

14. Press the bottom of the Pressure washer switch to turn off the washer.

15. Point the high pressure wand in a safe direction and squeeze the trigger to relieve pressure from the system.

16. Turn off the machine.

17. Disassemble the hose and wand and return them to the proper storage locations.

18. Close the front shroud.

OPERATION

MACHINE TROUBLESHOOTING

Problem	Cause	Remedy
Trailing water—poor or no water pickup	Scrub vacuum fan turned off	Turn on vacuum fan
	Worn squeegee blades	Rotate or replace squeegee blades
	Squeegee out of adjustment	Adjust squeegee
	No detergent in solution tank causing squeegee to chatter	Add detergent to solution tank
	Vacuum hose clogged	Flush vacuum hoses
	Vacuum screen dirty	Clean vacuum screen
	Recovery tank cover seals worn	Replace seals
	Debris caught in squeegee	Remove debris
	Vacuum hose to squeegee or recovery tank disconnected or damaged	Reconnect or replace vacuum hose
	Recovery tank cover not completely closed	Check for obstructions and make sure cover is closed properly
Scrub vacuum fan will not turn on	Vacuum fan / squeegee button turned off	Turn on Vacuum fan / squeegee button
	Recovery tank full	Drain recovery tank
	Foam filling recovery tank	Empty recovery tank Use less detergent/or use defoamer
	Recovery tank sensor dirty or stuck	Clean or replace sensor
Little or no solution flow to the floor (Conventional Scrubbing Mode)	Solution tank empty	Fill solution tank
	Solution flow turned off	Turn on solution flow
	Solution supply lines plugged	Flush solution supply lines
Excessive dusting	Brush skirts and dust seals worn, damaged, or out of adjustment	Replace or adjust brush skirts and/or brush seals
	Hopper dust filter clogged	Shake and/or replace dust filter
	Sweep vacuum fan seal damaged	Replace vacuum fan seal
	Sweep vacuum fan failure	Call Tennant service representative
	Thermo—Sentry tripped	Allow Thermo—Sentry to cool
Poor sweeping performance	Worn brush bristles	Replace brushes
	Brush pressure set too light	Increase brush pressure
	Main brushes not properly adjusted	Adjust brushes
	Debris caught in main brush drive mechanism	Remove debris from main brush drive mechanism
	Main and/or side brush drive failure	Call Tennant service representative
	Hopper is full	Empty hopper
	Hopper lip skirts worn or damaged	Replace lip skirts
	Improper main brushes	Call Tennant service representative
Poor scrubbing performance	Improper detergent or brushes	Call Tennant service representative
	Solution tank empty	Fill solution tank
	Debris caught on main brushes	Remove debris

Problem	Cause	Remedy
Poor scrubbing performance	Worn main brushes	Replace brushes
	Brush pressure set too light	Increase brush pressure
FaST System does not operate	FaST button is turned off	Turn on the FaST button
	Clogged FaST-PAK supply hose and/or connector	Soak connector and hose in warm water and clean
	FaST-PAK carton is empty or not connected	Replace FaST-PAK carton and/or connect supply hose
	FaST system is not primed	To prime, operate the FaST solution system for a few minutes
	Clogged filter screen	Drain solution tank, remove and clean filter screen
	Blown fuse	Call Tennant service representative
	Faulty solution pump	Call Tennant service representative
ES System does not operate	<i>ES button</i> is turned off	Turn on <i>ES button</i>
	ES sensor in tank dirty	Clean sensor
	Clogged ES pump filter	Clean ES filter
	Water level in recovery tank too low	Fill recovery tank about half full
	Water level in solution tank too low	Fill solution tank
Sweeping or Scrubbing functions do not turn on	Hopper is up	Completely lower hopper
	Fire in the hopper	Shut off machine. Extinguish fire. If necessary, call emergency personnel.
	Recovery tank full	Press the <i>Scrub vacuum fan/squeegee button</i> for one minute of extended water pickup. Empty recovery tank. ES models: activate the ES system to prevent this.

MAINTENANCE



MAINTENANCE CHART

The table below indicates the *Person Responsible* for each procedure.

O = Operator.

T = Trained Service Mechanic.

Interval	Person Resp.	Key	Description	Procedure	Lubricant /Fluid	No. of Service Points
Daily	O	1	Engine	Check oil level	EO	1
				Check coolant level in reservoir	WG	1
	O	10	Hydraulic fluid reservoir	Check fluid level	HYDO	1
	O	8, 9	Tank cover seals	Check for damage or wear	-	3
	O	3	Main brushes	Check for damage and wear	-	2
				Check squeegee blade for damage and wear	-	1
	O	4	Side brush (option)	Check for damage and wear	-	1
				Check squeegee blade for damage and wear	-	1
	O	6	Rear Squeegee Blade	Check for damage and wear	-	1
				Check deflection	-	1
	O	7	Side Squeegee Blades	Check for damage and wear	-	2
	O	8	Recovery tank	Clean	-	1
	O	8	Recovery tank, ES mode (option)	Clean ES filter	-	1
O	9	Solution tank, ES mode (option)	Clean	-	1	
O	5	Hopper	Clean hopper, debris screen, and hose	-	1	
20 Hours	O	5	Hopper dust filter	Check for damage, clean, replace if necessary	-	1
50 Hours	O	16	FaST / ec-H2O filter screen	Clean	-	1
	O	3	Main brushes	Rotate front to rear	-	2
	T	3	Main brushes	Check brush pattern and adjust if needed	-	2
	T	13	Front wheel	Torque wheel nuts (after initial 50 hours only)	-	1
	T	15	Battery	Clean and tighten battery cable connections (after initial 50 hours only)	-	1
50 Hours	T	1	Engine	Check belt tension	-	1

LUBRICANT/FLUID

EO Engine oil, 5W-30 SAE-SM or higher.

HYDO . **TennantTrue** premium hydraulic fluid or equivalent

WG Water and ethylene glycol anti-freeze, -34° C (-30° F)

SPL Special lubricant, Lubriplate EMB grease (Tennant part number 01433-1)

NOTE: More frequent maintenance intervals may be required in extremely dusty conditions.

MAINTENANCE

The table below indicates the *Person Responsible* for each procedure.

O = Operator.

T = Trained Service Mechanic.

Interval	Person Resp.	Key	Description	Procedure	Lubricant /Fluid	No. of Service Points
100 Hours	T	18	Radiator	Clean core exterior	-	1
	T	18	Hydraulic cooler	Clean core exterior	-	1
	T	1	Engine	Change oil and filter	EO	1
				Drain LPG vaporizer oil buildup	-	1
	O	13, 19	Tires	Check for damage	-	3
	T	6	Rear squeegee casters	Lubricate	SPL	2
	T	6	Rear squeegee	Check leveling	-	1
	O	2	Scrub head skirt	Check for damage or wear	-	1
200 Hours	T	12	Front wheel support bearings	Lubricate	SPL	2
	T	1, 17	Torque tube	Lubricate	SPL	4
	T	12	Steering cylinder	Lubricate	SPL	1
	T	1, 18	Radiator hoses and clamps	Check for tightness and wear	-	2
	T	11	Brake pedal	Check adjustment	-	1
	T	14	Hopper lift arm pivots	Lubricate	SPL	2
	T	5	Hopper door pivots	Lubricate	SPL	2
400 Hours	T	1	Engine	Replace air filter	-	1
				Replace fuel filter	-	1
	T	20	Rear wheel bearings	Check, lubricate, and adjust	SPL	2
800 Hours	T	10	Hydraulic reservoir	Replace strainer outlet	-	1
	T	-	Hydraulic hoses	Check for wear and damage	-	All
	T	1, 18	Cooling system	Flush	WG	2
	T	13	Propelling motor	Torque shaft nut	-	1
	T	13	Front wheel	Torque wheel nuts	-	1
	T	15	Battery	Clean and tighten battery cable connections	-	1

LUBRICANT/FLUID

EO . . . Engine oil, 5W-30 SM or higher.

HYDO . **TennantTrue** premium hydraulic fluid or equivalent

WG . . . Water and ethylene glycol anti-freeze, -34° C (-30° F)

SPL . . . Special lubricant, Lubriplate EMB grease (Tennant part number 01433-1)

NOTE: More frequent maintenance intervals may be required in extremely dusty conditions.

The table below indicates the *Person Responsible* for each procedure.

O = Operator.

S = Trained Service Mechanic.

Interval	Person Resp.	Key	Description	Procedure	Lubricant/ Fluid	No. of Service Points
1000 Hours	T	16	FaST system filters	Replace	–	2
	T	1	Engine	Replace spark plugs	–	4
	T	1	Engine	Inspect PCV system	–	1
	T	1, 19	Radiator hoses	Check for cracks or deterioration	–	2
1200 Hours	T	10	Hydraulic reservoir	* Replace fluid filter	–	1
2400 Hours	T	10	Hydraulic reservoir	* Change hydraulic fluid	HYDO	1
				* Replace strainer outlet		1
5000 Hours	T	1	Engine	Replace camshaft and balance shaft belts	–	2

LUBRICANT/FLUID

EO Engine oil, 5W–30 SAE–SM or higher.

HYDO . **TennantTrue** premium hydraulic fluid or equivalent

WG Water and ethylene glycol anti-freeze, –34° C (–30° F)

SPL Special lubricant, Lubriplate EMB grease (Tennant part number 01433–1)

NOTE: More frequent maintenance intervals may be required in extremely dusty conditions.

MAINTENANCE

YELLOW TOUCH POINTS

This machine features easy to find yellow touch points for simple service items. No tools are required to perform these maintenance operations.

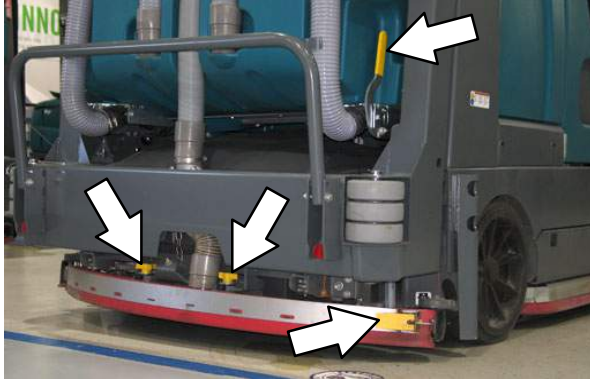

LUBRICATION

FOR SAFETY: Before leaving or servicing machine, stop on level surface, set parking brake, turn off machine, and remove key.

ENGINE OIL

Check the engine oil level daily. Change the oil and oil filter after every 100 hours of operation.



Fill the engine with oil until the oil is between the indicator marks on the dipstick. **DO NOT** fill past the top indicator mark.

The engine oil capacity for **Mitsubishi engines** is 4.7 L (5 qt) with oil filter.

SQUEEGEE CASTER BEARINGS

Lubricate the squeegee caster bearings after every 100 hours of operation.

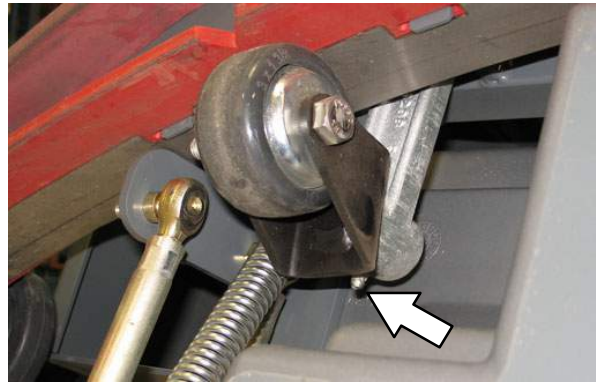

FRONT WHEEL SUPPORT BEARING

Lubricate the front wheel support bearings after every 200 hours of operation. Both front wheel support grease fittings are located underneath the frame support plate.



STEERING CYLINDER BEARING

Lubricate the steering cylinder after every 200 hours of operation. The steering cylinder bearing is located next to the front wheel support.



REAR WHEEL BEARINGS

Inspect the rear wheel bearings for seal damage, and repack and adjust every 400 hours of operation. Use Lubriplate EMB grease (Tennant part number 01433-1).

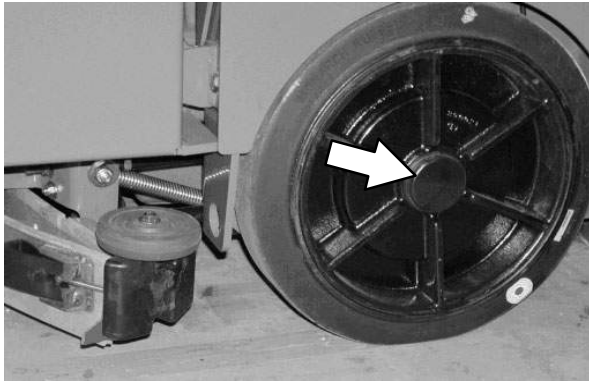
**LIFT ARM LATCH**

Clean and lubricate the lift arm latch and latch stop after every 200 hours of operation.

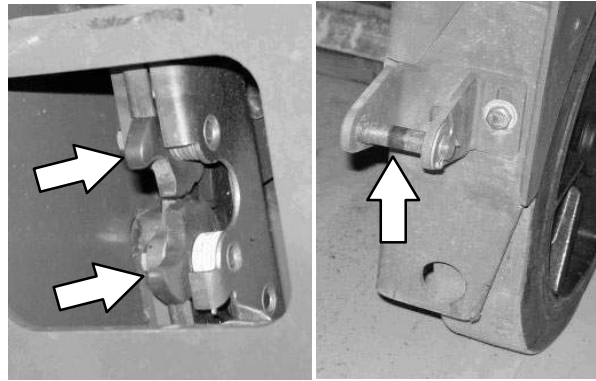
**HOPPER LIFT ARM PIVOTS**

Lubricate the hopper lift arm pivots after every 200 hours of operation.

**TORQUE TUBES**

Lubricate the torque tubes after every 200 hours of operation. The torque tube grease fittings on the operator side of the machine are located beneath the fuel tank.

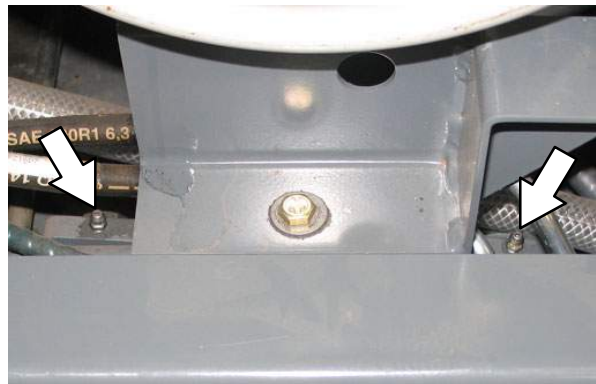
**HOPPER DOOR PIVOTS**

Lubricate the hopper door pivots after every 200 hours of operation.



On the other side of the machine the torque tube grease fittings are located beneath the propel pump.

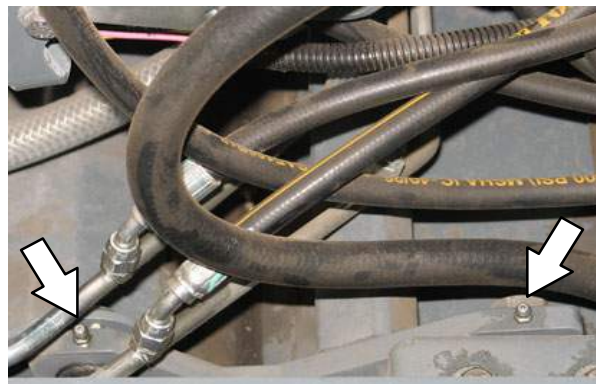

MAINTENANCE

HYDRAULICS

Check the hydraulic fluid level at operating temperature daily. The hydraulic fluid level should be between the two lines on the hydraulic gauge. The hopper must be down when checking hydraulic fluid level.

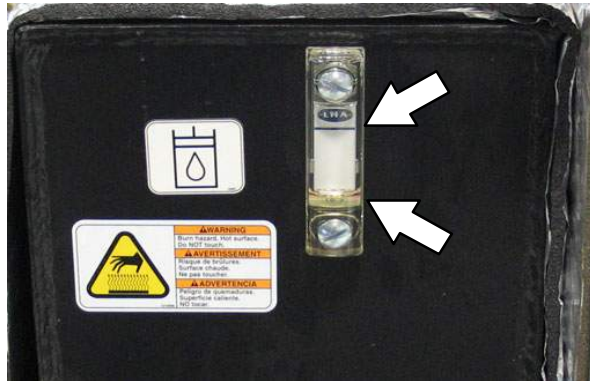

ATTENTION! Do not overfill the hydraulic fluid reservoir or operate the machine with a low level of hydraulic fluid in the reservoir. Damage to the machine hydraulic system may result.

Drain and refill the hydraulic fluid reservoir with new **TennantTrue** premium hydraulic fluid after every 2400 hours of operation.

! WARNING: Burn hazard. Hot surface. Do NOT touch.

Replace the filler cap after every 800 hours of operation. Apply a light film of hydraulic fluid onto the filler cap gasket before installing the cap onto the reservoir.



Replace the hydraulic fluid filter after every 1200 hours of operation or if the hydraulic reservoir gauge is in the yellow/red zone when the reservoir hydraulic fluid is approximately 32° C (90° F).



Replace the hydraulic strainer outlet after every 2400 hours of operation.

HYDRAULIC FLUID

There are three fluids available for different ambient air temperature ranges:

TennantTrue premium hydraulic fluid (Extended Life)			
Part Number	Capacity	ISO Grade Viscosity Index (VI)	Ambient Air Temperature Ranges
1057710	3.8 L (1 gal)	ISO 100 VI 126 or higher	19° C (65° F) or higher
1057711	19 L (5 gal)		
1069019	3.8 L (1 gal)	ISO 68 VI 155 or higher	7 to 43° C (45 to 110° F)
1069020	19 L (5 gal)		
1057707	3.8 L (1 gal)	ISO 32 VI 163 or higher	16° C (60° F) or lower
1057708	19 L (5 gal)		

If using a locally-available hydraulic fluid, be sure the specifications match Tennant hydraulic fluid specifications. Substitute fluids can cause premature failure of hydraulic components.

ATTENTION! Hydraulic components depend on system hydraulic fluid for internal lubrication. Malfunctions, accelerated wear, and damage will result if dirt or other contaminants enter the hydraulic system.

HYDRAULIC HOSES

Check the hydraulic hoses after every 800 hours of operation for wear or damage.

FOR SAFETY: When servicing machine, use cardboard to locate leaking hydraulic fluid under pressure.

High pressure fluid escaping from a very small hole can almost be invisible, and can cause serious injuries.

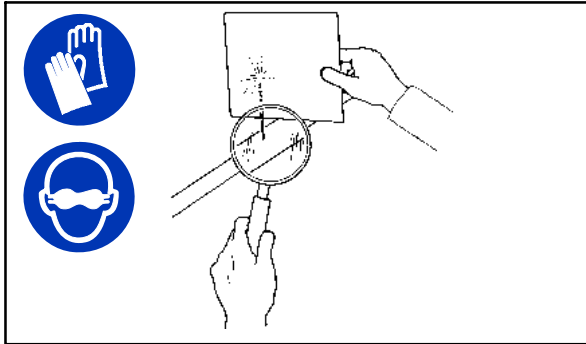

Consult a physician immediately if injury results from escaping hydraulic fluid. Serious infection or reaction can occur if proper medical treatment is not given immediately.

Contact a mechanic or supervisor if a leak is discovered.

ENGINE

FOR SAFETY: Before leaving or servicing machine, stop on level surface, set parking brake, turn off machine, and remove key.

COOLING SYSTEM

FOR SAFETY: When servicing machine, avoid contact with hot engine coolant. Do not remove cap from radiator when engine is hot. Allow engine to cool.

Check the coolant level in the reservoir daily. The coolant level must be between the indicator marks when the engine is cold. Refer to the coolant manufacture for water/coolant mixing instructions.

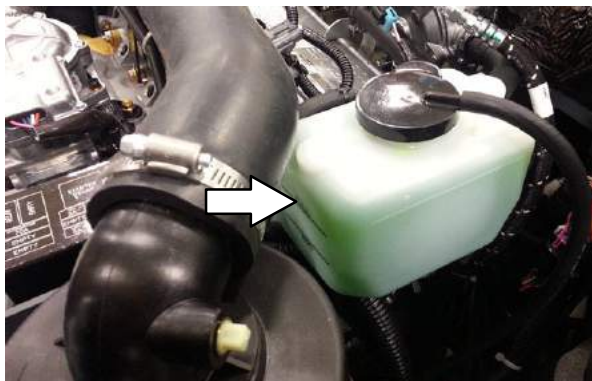

Flush the radiator and the cooling system after every 800 hours of operation.

Check the radiator hoses and clamps after every 200 hours of operation. Tighten loose clamps. Replace damaged hoses and clamps.

Check the radiator hoses for cracks and deterioration after every 1000 hours of operation.

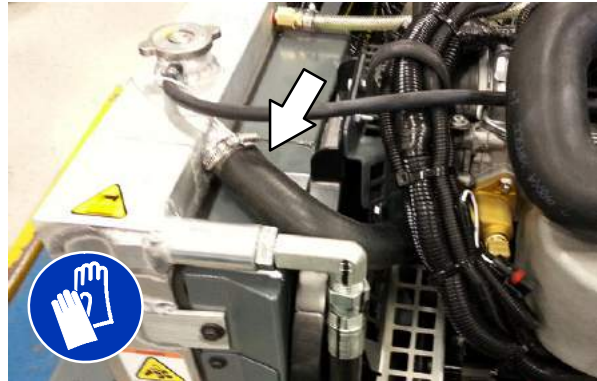

Check the radiator core exterior and hydraulic cooler fins for debris after every 100 hours of operation. Blow or rinse all dust through the grille and radiator fins, in the opposite direction of normal air flow. Be careful to not bend the cooling fins when cleaning. Clean thoroughly to prevent the fins from becoming encrusted with dust. To avoid cracking the radiator, allow the radiator and cooler fins to cool before cleaning.

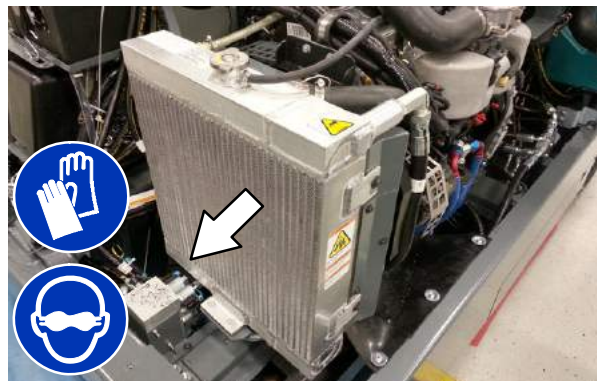

FOR SAFETY: When servicing machine, wear eye and ear protection when using pressurized air or water.

MAINTENANCE

AIR FILTER

Replace the air filter after every 400 hours of operation.

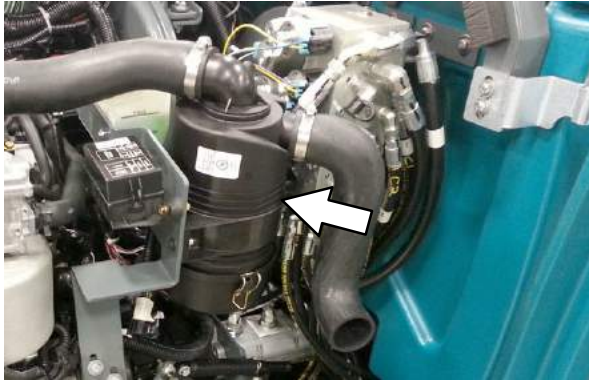

FUEL FILTER (LPG)

Replace the LPG fuel filter after every 400 hours of operation.

Disassemble the fuel lock off valve to access the LPG fuel filter.

FOR SAFETY: When servicing machine, keep flames and sparks away from fuel system service area. Keep area well ventilated.



FUEL FILTER (Gasoline)

Replace the gasoline fuel filter after every 400 hours of operation.

FOR SAFETY: When servicing machine, keep flames and sparks away from fuel system service area. Keep area well ventilated.



LPG VAPORIZER

Drain oil buildup in the LPG vaporizer after every 100 hours of operation.

FOR SAFETY: When servicing machine, keep flames and sparks away from fuel system service area. Keep area well ventilated.



ENGINE BELT

Check the belt tension after every 50 hours of operation. Adjust tension as necessary. Proper belt tension is 13 mm (0.50 in) from a force of 4 to 5 kg (8 to 10 lb) applied at the mid-point of the longest span.

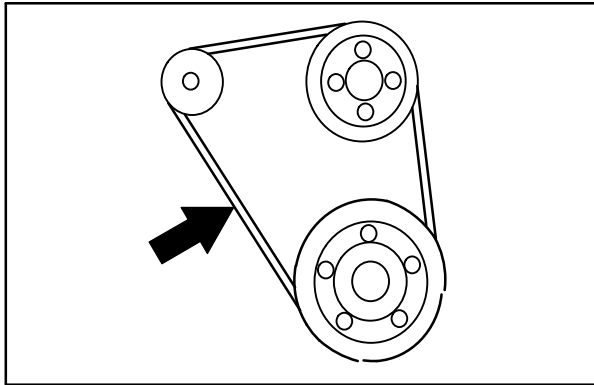

WARNING: Moving belt and fan. Keep away.

PCV SYSTEM

Inspect the PCV system after every 1000 hours of operation.

**SPARK PLUGS**

Replace the spark plugs after every 1000 hours of operation.

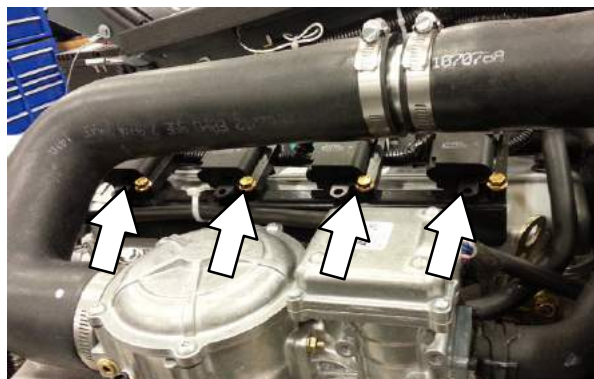
**CAMSHAFT AND BALANCE SHAFT BELTS**

Replace the camshaft and balance shaft belts after every 5000 hours of operation.

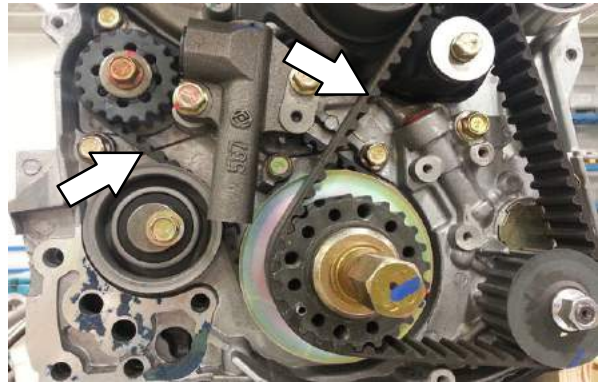
**BATTERY**

Clean and tighten the battery connections after the first 50 hours of operation and after every 800 hours after that. Do not remove the vent plugs from the battery or add water to the battery.

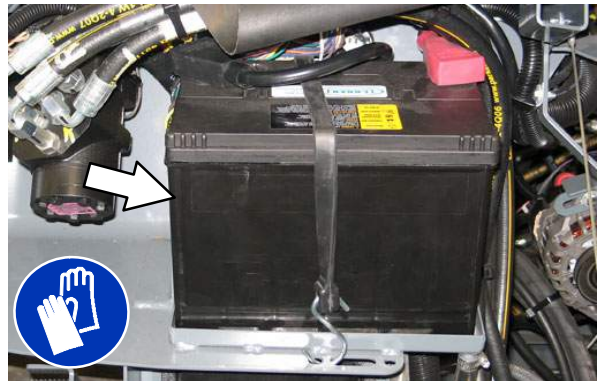

FOR SAFETY: When servicing machine, avoid contact with battery acid.

FUSES AND RELAYS

RELAY PANEL FUSES AND RELAYS

Fuses are one-time protection devices designed to protect the wire harness by stopping the flow of current in the event of a circuit overload. *Relays* switch the electrical power going to the machine electrical systems on/off. Remove the relay panel cover to access *fuses* and *relays*.

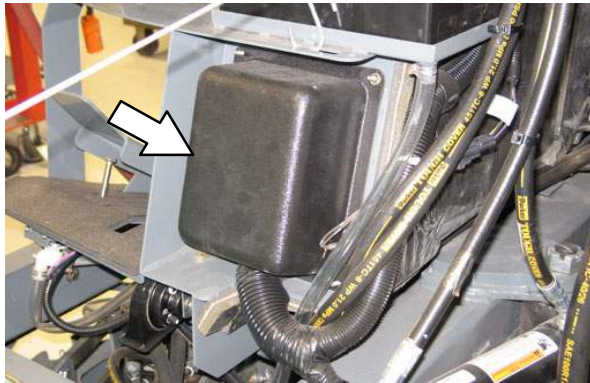

NOTE: Always replace a fuse with a fuse of the same amperage. Extra 15 Amp fuses are provided inside the relay panel drawer on the relay panel.

Refer to the diagram below for locations of the *fuses* and *relays* on the relay panel.

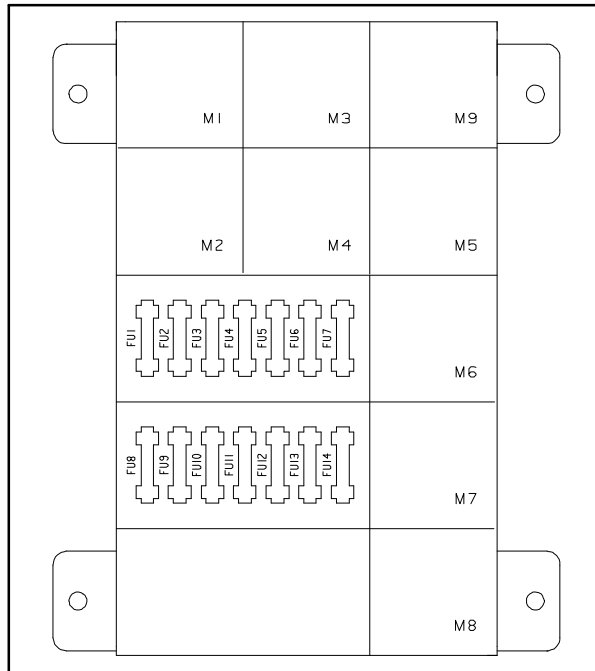

Refer to the table below for the *fuses* and circuits protected.

Fuse	Rating	Circuit Protected
FU1	15 A	Auxiliary Relays/Engine Controls
FU2	15 A	Shaker
FU3	15 A	Horn
FU4	15 A	Not Used
FU5	15 A	Scrub Vacuum/Main Brush/Squeegee Down/Hopper Up
FU6	15 A	Enable/Side Brush/Sweep Vacuum
FU7	15 A	Solution/Hopper Latch and Door/Auto Fill/Reverse/Shaker
FU8	15 A	ES/FaST/Detergent/Hopper Down/Spray Wand
FU9	15 A	Lights
FU10	15 A	Unswitched B+ for controller board
FU11	15 A	Not Used: Options
FU12	15 A	Spray Nozzle Pump
FU13	15 A	AC/Heater Option
FU14	15 A	Not Used

-	20 A	ec-H2O (near ignition switch)
---	------	-------------------------------

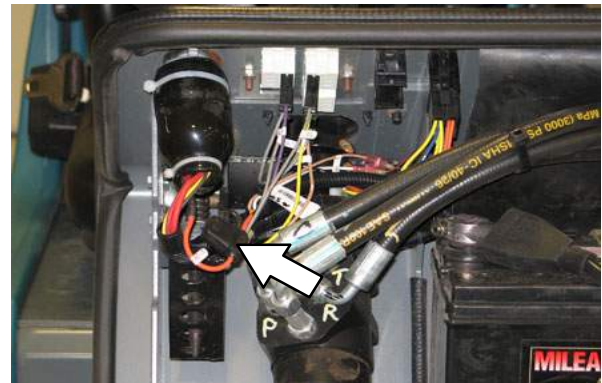

Refer to the table below for the *relays* and circuits controlled.

Relay	Rating	Circuit Controlled
M1	12 VDC, 40 A	Auxiliary 1
M2	12 VDC, 40 A	Auxiliary 2
M3	12 VDC, 40 A	Shaker
M4	12 VDC, 40 A	Reverse
M5	12 VDC, 40 A	Horn
M6	12 VDC, 40 A	Shutdown
M7	12 VDC, 40 A	Starter
M8	12 VDC, 40 A	Auxiliary 3
M9	12 VDC, 40 A	Spare

ENGINE HARNESS FUSES AND RELAYS

The *engine harness fuses and relays* are located in the fuse box inside the engine compartment. Refer to the fuse box cover for locations of engine harness fuses and relays.



NOTE: Always replace a fuse with a fuse of the same amperage.

OPTIONAL RELAYS

The optional spray nozzle or pressure wand relay is located behind the battery. The optional FaST scrubbing system relay is located behind the seat.

Relay	Rating	Circuit Controlled
-	12 VDC. 40 A	Spray Wand
-	12 VDC. 40 A	Pressure Washer
-	12 VDC. 40 A	FaST

CIRCUIT BREAKERS (ec-H2O)

Circuit breakers are resettable electrical circuit protection devices that stop the flow of current in the event of a circuit overload. Once a circuit breaker is tripped, allow breaker to cool and then press the reset button to manually reset the breaker.



CLEANING THE HOPPER DUST FILTER

Shake the dust filter before emptying the hopper and at the end of every shift. Inspect and clean the filter after every 20 hours of operation. Replace damaged dust filters.

NOTE: The dust filter may need to be cleaned at more frequent intervals if the machine is used in extremely dusty conditions.

Use one of the following methods to clean the dust filter:

SHAKING—Press the *filter shaker button*.

TAPPING—Tap the filter, with the dirty side down, gently on a flat surface. **Do not damage the edges of the filter.** The filter will not seal properly in the filter frame if the edges of the filter are damaged.

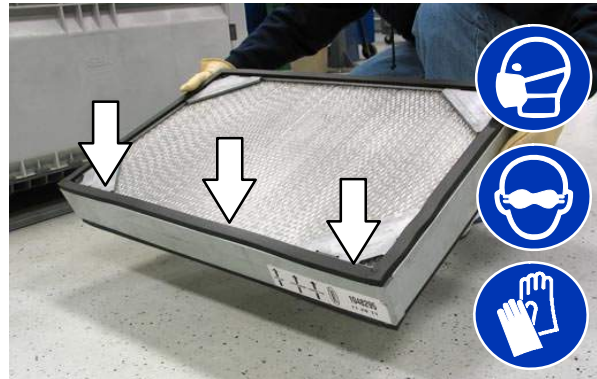

AIR—Always wear eye protection when using compressed air. Blow air through the dust filter opposite the direction of the arrows. Never use more than 690 kPa (100 psi) of air pressure and never hold the nozzle closer than 50 mm (2 in) to the filter. This may be done with the dust filter in the machine.

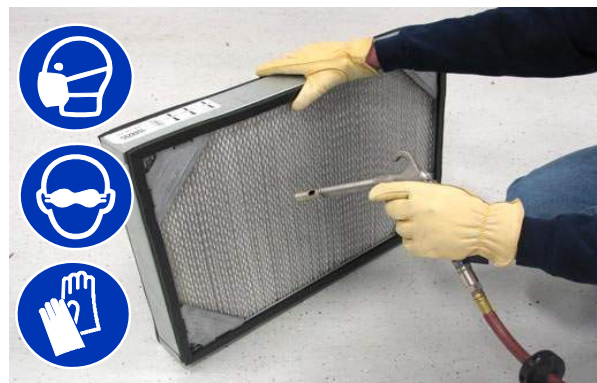

MAINTENANCE

WATER—Rinse the dust filter with a low pressure garden hose through the dust filter opposite the direction of the arrows.



NOTE: If water is used to clean the dust filter, be sure the filter is completely dry before reinstalling it into the hopper. **Do Not** reinstall a wet dust filter.

THERMO-SENTRY

The Thermo-Sentry, located inside the hopper, senses the temperature of the air pulled up from the hopper. If there is a fire in the hopper, the Thermo-Sentry stops the vacuum fan and cuts off the air flow. The Thermo-Sentry automatically resets after cooling down.

MAIN BRUSHES

FOR SAFETY: Before leaving or servicing machine, stop on level surface, set parking brake, turn off machine, and remove key.

Check the main brushes daily for tangled wire or string, wear, and damage.

Replace the brushes when they no longer clean effectively.

Rotate the brushes from front to rear after every 50 hours of machine operation for maximum brush life and best scrubbing performance.

NOTE: Replace brushes in sets of two. Otherwise one scrub brush may scrub more aggressively than the other.

REPLACING OR ROTATING THE MAIN BRUSHES

The front brush can be accessed on the left side of the machine and rear brush can be accessed on the right side of the machine.

1. Raise the scrub head.

FOR SAFETY: Before leaving or servicing machine, stop on level surface, set parking brake, turn off machine, and remove key.

2. Open the outer brush doors.



3. Open the inner brush doors.



4. Remove the brush idler plates.

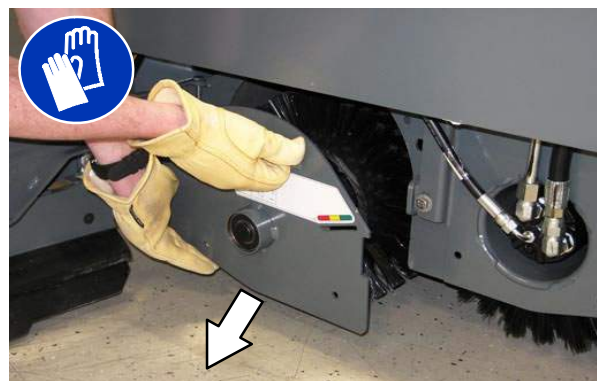

- Pull the brushes out from the scrub head.



- Install the new or rotated brushes by pushing down on the ends while sliding them onto the drive motor hubs.



- If rotating the brushes, always rotate the front with the back so that they wear evenly. They may be rotated end-for-end as well.

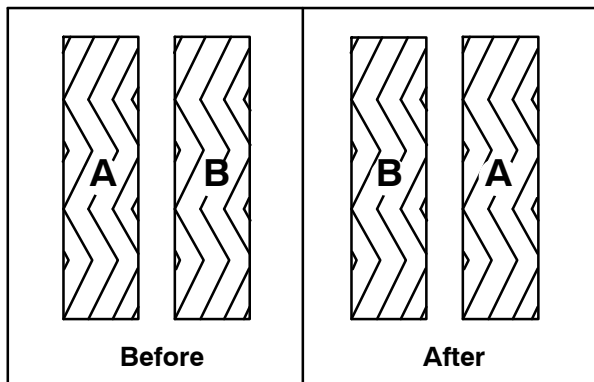

- Reinstall the brush idler plates.
- Close the inner and outer brush doors.
- Check the brush pattern and adjust if needed after rotating them. Refer to *CHECKING AND ADJUSTING THE MAIN BRUSH PATTERN*.

CHECKING THE MAIN BRUSH PATTERN

- Apply chalk, or a similar marking material, to a smooth and level section of the floor.

NOTE: If chalk or other material is not available, allow the brush to spin on the floor for two minutes. A polish mark will remain on the floor.

- Raise the scrub head, then position the brushes over the chalked area.
- Set the parking brake.
- Press the *1-STEP Sweep* button to lower the scrub head. Set the brush pressure to the lowest setting and allow the brushes to operate for 15 to 20 seconds. Keep the scrub head in one spot in the chalked area.
- Raise the scrub head, release the parking brake, and drive the machine away from the chalked area.

FOR SAFETY: Before leaving or servicing machine, stop on level surface, set parking brake, turn off machine, and remove key.

- Observe the brush patterns. If the brush pattern is the same width across the entire length of each brush and both brushes are the same width, no adjustment is necessary.

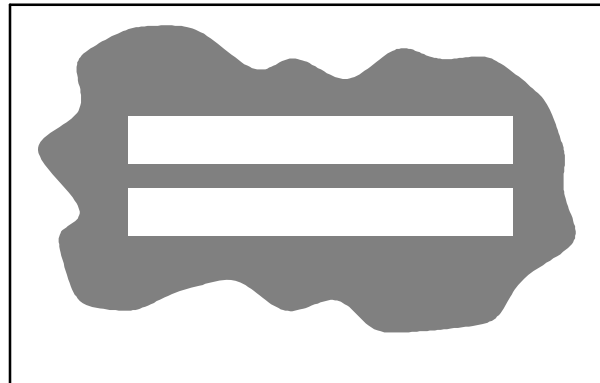

MAINTENANCE

7. If the brush patterns are tapered, see *ADJUSTING THE MAIN BRUSH TAPER* section of this manual.

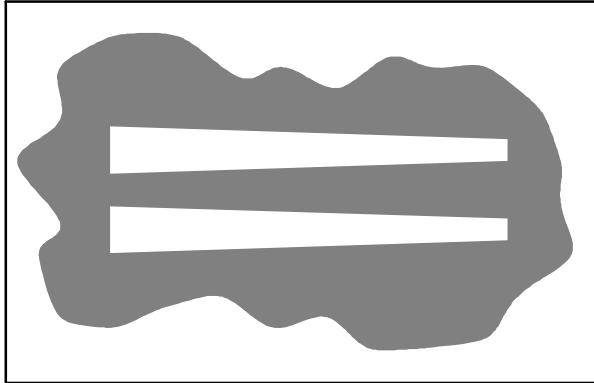

8. The brush patterns should be 50 to 75 mm (2 to 3 in) wide with the brushes in the lowered position and both patterns should be the same width. If the width of the brushes is not the same, see *ADJUSTING THE MAIN BRUSH WIDTH* section of this manual.

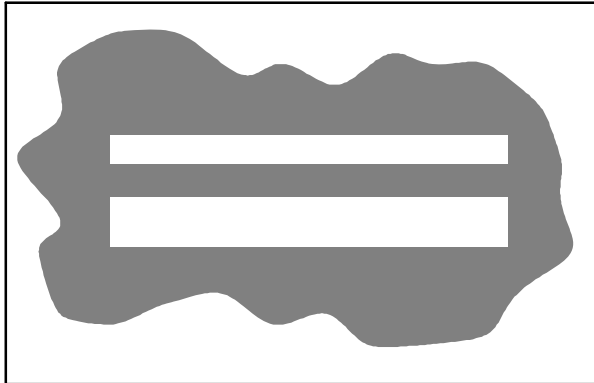

ADJUSTING THE MAIN BRUSH TAPER

1. Loosen the four mounting bolts on the brush drive housing.

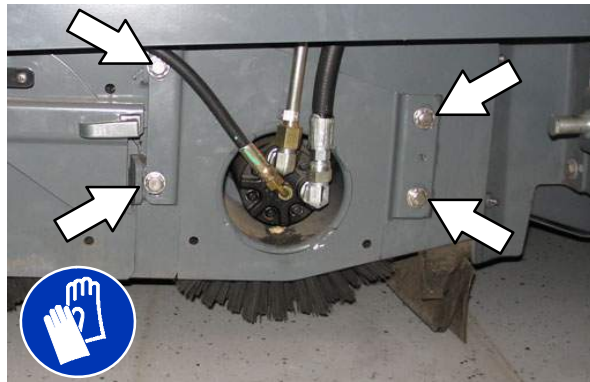

2. Move the brush drive housing up to decrease the pattern width on that side of the scrub head or down to increase the pattern width on that side of the scrub head.

3. Tighten the mounting bolts.
4. Recheck the pattern. Readjust if necessary.

ADJUSTING THE MAIN BRUSH WIDTH

1. Adjust the length of the drag links on both sides of the scrub head. Lengthen the drag links to increase the rear brush pattern width. Shorten the drag links to increase the front brush pattern. Always adjust the nut on each drag link an equal number of turns.

NOTE: Two full turns of the drag link adjustment bolt will change the brush pattern approximately 25 mm (1 in).



2. Recheck the pattern. Readjust if necessary.

SIDE BRUSH (OPTION)

FOR SAFETY: Before leaving or servicing machine, stop on level surface, set parking brake, turn off machine, and remove key.

Check the side brush daily for wear or damage. Remove any tangled string or wire from the side brush or side brush drive hub.

REPLACING THE SIDE BRUSH

Replace the brush when it no longer cleans effectively or when the bristles are worn down to the yellow indicators.

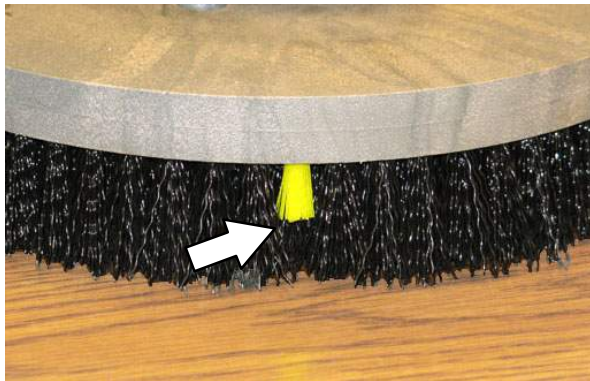

1. If necessary, raise the side brush.
2. Turn the brush until the spring handles are visible through the access hole in the side brush assembly.
3. Squeeze the spring handles and let the side brush drop to the floor.

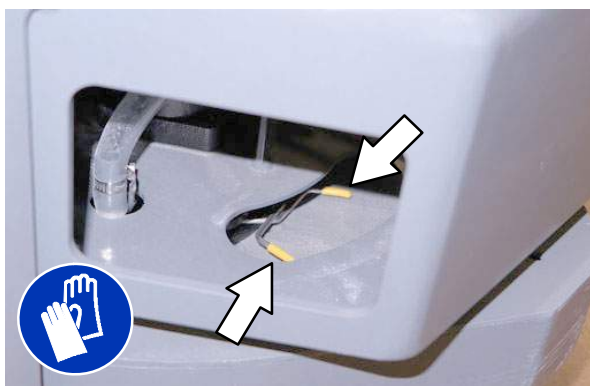

4. Remove the side brush from underneath the side brush assembly.

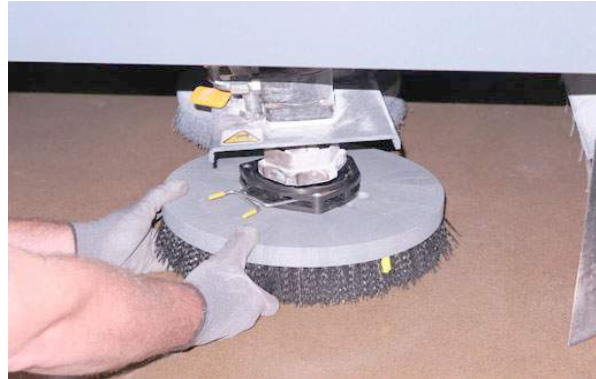

5. Set the brush spring open on the new brush to make installation easier.

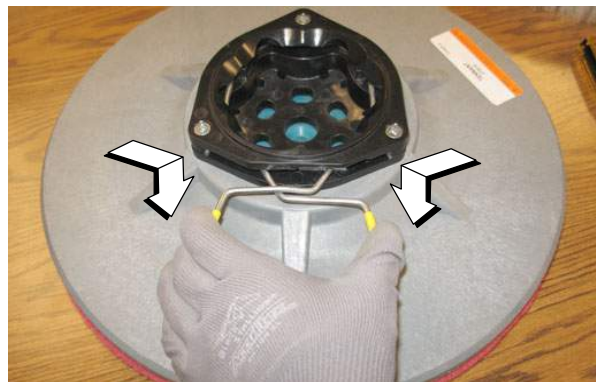

6. Place the new side brush underneath the side brush assembly and lift the side brush up onto the side brush hub until the brush locks onto the hub.

FaST SYSTEM

REPLACING THE FaST-PAK CARTON

FOR SAFETY: Before leaving or servicing machine, stop on level surface, set parking brake, turn off machine, and remove key.

1. Open the side access door.
2. Slide the seat completely forward.
3. Squeeze the button on the FaST supply hose connector, then pull the empty FaST-PAK carton out from the compartment and discard.

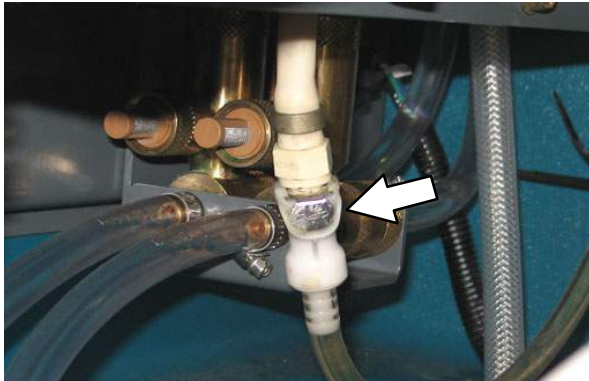

4. Remove the perforated knock outs from the new FaST-PAK carton. Do Not remove the bag from the carton. Pull out the hose connector located on the bottom of the bag and remove the hose cap from the connector.

NOTE: The FaST-PAK Floor Cleaning Concentrate is specially designed for use with the FaST system scrubbing application. NEVER use a substitute. Other cleaning solutions may cause FaST system failure.

5. Slide the FaST-PAK carton into the FaST-PAK bracket.
6. Connect the FaST supply hose to the FaST-PAK hose connector.
7. Scrub with the FaST system for a few minutes to allow the detergent to reach maximum foaming.

CLEANING THE FaST SUPPLY HOSE CONNECTOR

Soak the connector in warm water if detergent buildup is visible. When a FaST-PAK carton is not installed, store the supply hose connector on the storing plug to prevent the hose from clogging.

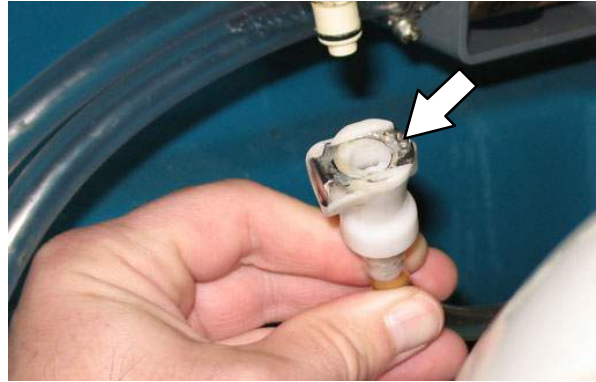

CLEANING THE FaST SYSTEM FILTER SCREEN

The FaST system filter screen filters water from the solution tank as the water flows into the FaST system.

Remove the filter screen bowl and clean the filter screen after every 50 hours of operation. Empty the solution tank before removing the filter.

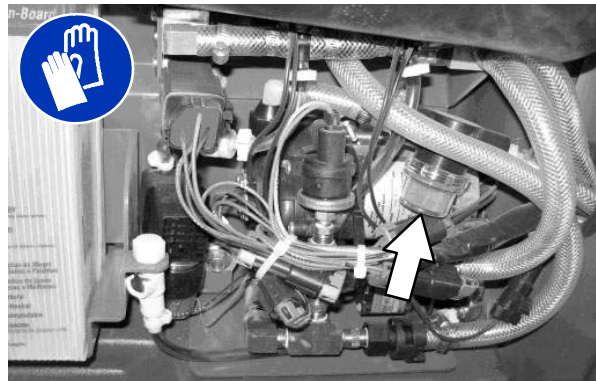

REPLACING THE FaST SYSTEM FILTERS

Replace the FaST system filters after every 1000 hours of operation. Empty the solution tank before replacing the filters.

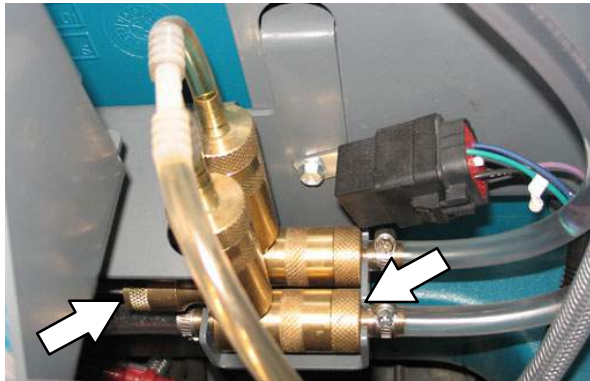

***ec-H2O* MODULE FLUSH PROCEDURE**

This procedure is only required when an alarm sounds and the *ec-H2O* system indicator light begins to blink red.

FOR SAFETY: Before leaving or servicing machine, stop on level surface, set parking brake, turn off machine.

1. Remove both flush hoses from the storage bag located behind the operator seat.
2. Lock the operator seat cover open.

3. Disconnect the *ec-H2O* system intake hose from the solution supply hose and connect the intake flush hose (gray connector) to the *ec-H2O* system intake hose.



4. Disconnect the *ec-H2O* system outlet hose from the hose to the scrub head and connect the outlet flush hose (black connector) to the *ec-H2O* system outlet hose.



5. Place the *ec-H2O* system intake hose into a container containing 5 gallons (19 liters) of white or rice vinegar. Place the outlet hose into an empty container.



MAINTENANCE

6. Turn the key to the on position without starting the engine.
7. Press and release the *ec-H2O* module flush switch to start the flush cycle.

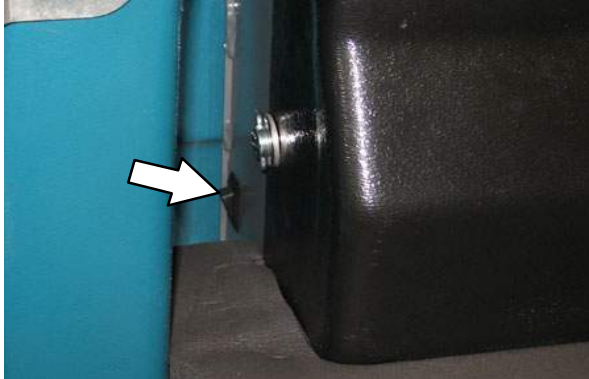

NOTE: The module will automatically shut off when the flush cycle is complete (approx. 7 minutes). The module must run the full 7 minute cycle in order to reset the system indicator light and alarm.

8. After the 7 minute flush cycle, remove the siphon hose from the container of vinegar and place the siphon hose into a container of cool clean water. Press the flush switch again to rinse out any remaining vinegar from the module. After 1–2 minutes, press the flush switch to turn off the module.
9. Disconnect the flush hoses from the *ec-H2O* system intake hose and outlet hose and return the flush hoses to the storage bag.
10. Reconnect *ec-H2O* intake and outlet hoses. If the *ec-H2O* system indicator light continues to flash, repeat the flush procedure. If the problem persists, contact an Authorized Service Center.
11. Close the operator seat cover.

CLEANING THE *ec-H2O* FILTER SCREEN

Remove and clean the *ec-H2O* filter screen after every 50 hours of operation.

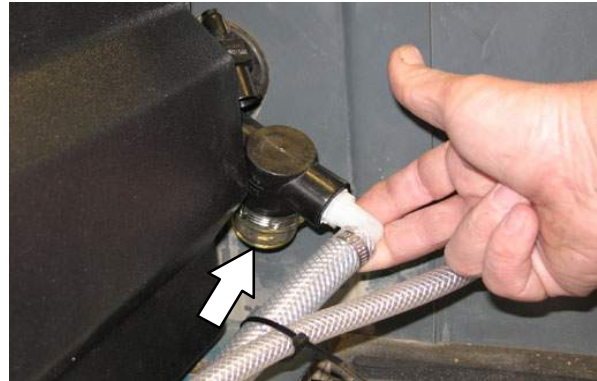

SQUEEGEE BLADES

FOR SAFETY: Before leaving or servicing machine, stop on level surface, set parking brake, turn off machine, and remove key.

Check the squeegee blades for damage and wear daily. When the blades become worn, rotate the blades end-for-end or top-to-bottom to a new wiping edge. Replace blades when all edges are worn.

Check the deflection of the squeegee blades daily or when scrubbing a different type of surface. Check the leveling of the rear squeegee every 100 hours of operation.

REPLACING (OR ROTATING) THE REAR SQUEEGEE BLADES

1. Lower the scrub head.
2. Disconnect the vacuum hose from the rear squeegee assembly.

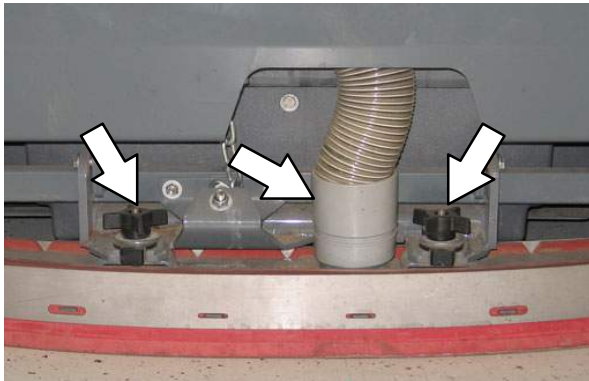

3. Remove both mounting knobs from the rear squeegee assembly.
4. Turn on the machine, raise the scrub head, and turn off the machine.
5. Remove the rear squeegee assembly from the machine.
6. Loosen the rear retaining band tension latch and open the retaining band.

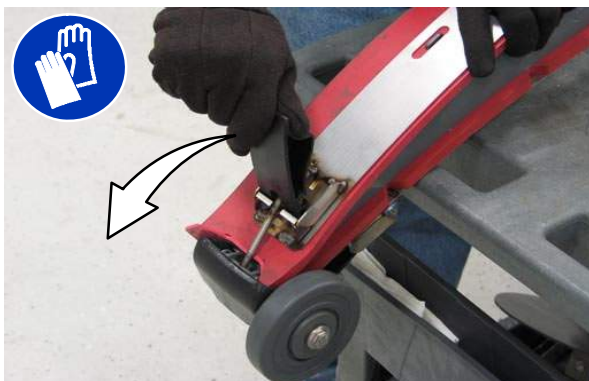

7. Remove the rear squeegee.



8. Install the new rear squeegee blade or rotate the existing blade to the new edge. Be sure all the holes in the squeegee blade are hooked onto the tabs.



9. Reinstall the rear retaining band aligning the tabs with the holes.



MAINTENANCE

10. Tighten the rear retaining band tension latch.
11. Loosen the front retaining band tension latch and open the retaining band.



12. Remove the front squeegee.



13. Install the new front squeegee blade or rotate the existing blade to the new edge. Be sure the holes in the squeegee blade are hooked onto the tabs.



14. Reinstall the front retaining band aligning the tabs with the notches.



15. Tighten the front retaining band tension latch.
16. Reinstall the rear squeegee assembly onto the machine.
17. Check and adjust the rear squeegee if necessary. Refer to *ADJUSTING THE REAR SQUEEGEE BLADE DEFLECTION* and *LEVELING THE REAR SQUEEGEE* sections of this manual.

REPLACING OR ROTATING THE SIDE SQUEEGEE BLADES

1. If necessary, raise the scrub head.

FOR SAFETY: Before leaving or servicing machine, stop on level surface, set parking brake, turn off machine, and remove key.

2. Open the outer brush doors.
3. Unhook the latch on the side squeegee retaining band from the side squeegee assembly.

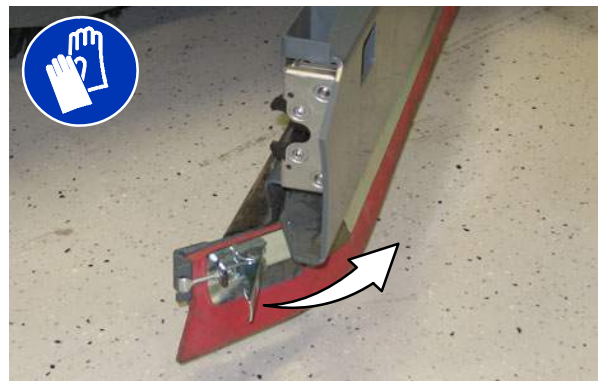

4. Remove the retaining band from the side squeegee assembly.



7. Reattach the side squeegee retaining band to the side squeegee assembly.



5. Remove the side squeegee blade. If the outer edge of the squeegee blade is not worn, rotate the squeegee blade with the blade from the other side of the machine. Discard the squeegee blade if both edges are worn.

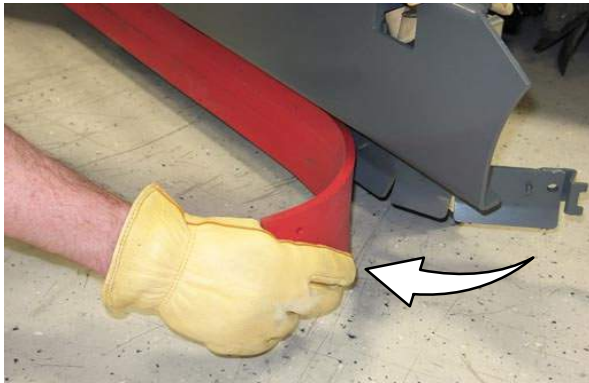

8. Hook the latch on the side squeegee retaining band.

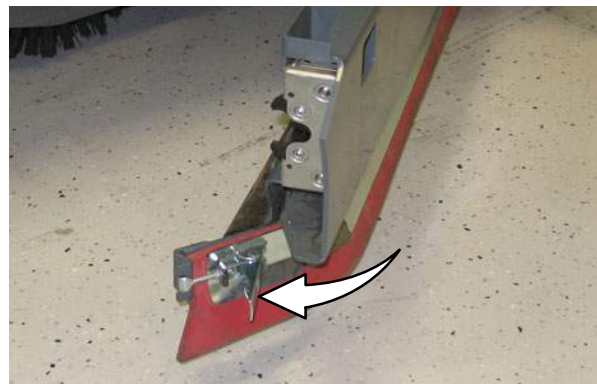

6. Install the new or rotated squeegee blades.



9. Close the outer brush door.

MAINTENANCE

REPLACING OR ADJUSTING THE SIDE BRUSH SQUEEGEE BLADE (OPTION)

FOR SAFETY: Before leaving or servicing machine, stop on level surface, set parking brake, turn off machine, and remove key.

Check the side brush squeegee blade for damage and wear daily. Replace the blade if the leading edge is torn or worn half-way through the thickness of the blade.

1. Lower the scrub head.
2. Pull the pins and remove the squeegee bumper.

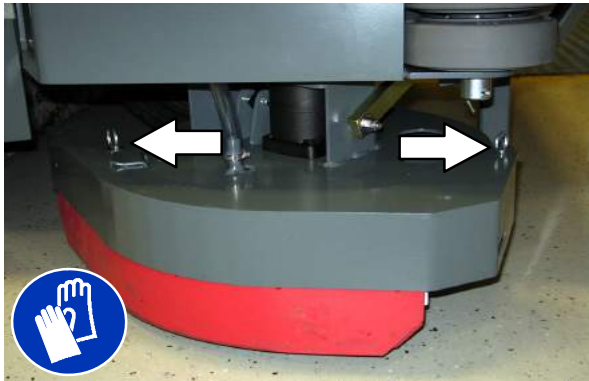

3. Open the retaining band tension latch.

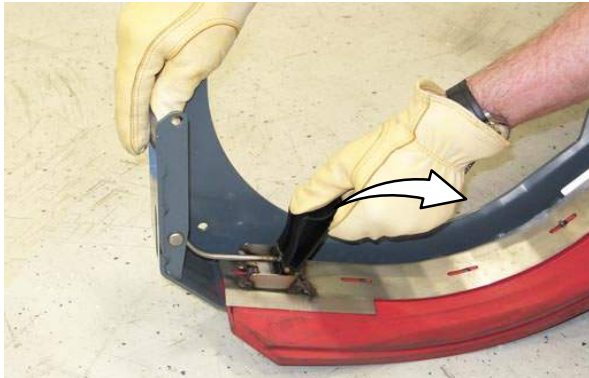

4. Remove the squeegees, spacer, and retainer from the squeegee bumper.

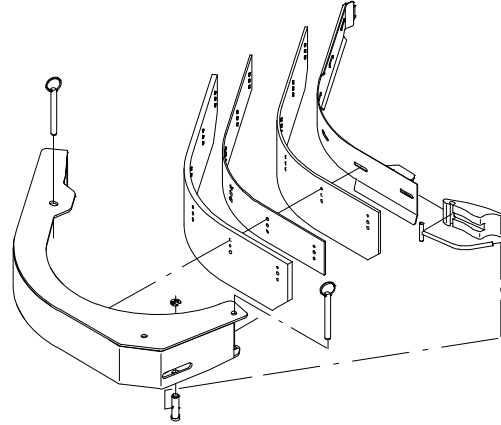

NOTE: The side brush squeegee blades have different holes for changing height adjustment.

5. Reinstall the squeegees, spacer, and retainer to the squeegee bumper by aligning the appropriate holes to the pins on the bumper.

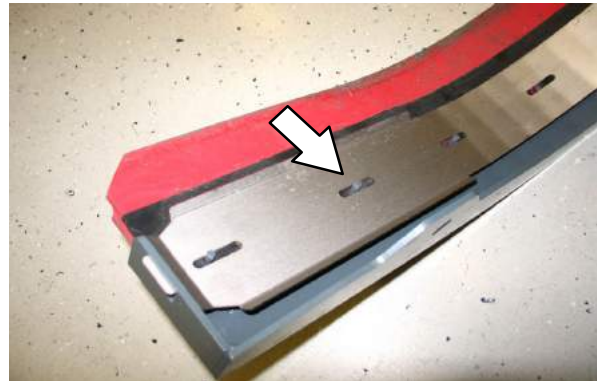

6. Reinstall the retaining band tension latch.
7. Reinstall the squeegee bumper and reinsert the pins.

LEVELING THE REAR SQUEEGEE

Leveling the squeegee assures the entire length of the squeegee blade is in even contact with the surface being scrubbed. Perform this adjustment on an even and level floor.

1. Lower the squeegee and drive the machine forward a few meters (feet).

FOR SAFETY: Before leaving or servicing machine, stop on level surface, set parking brake, turn off machine, and remove key.

2. Look at the deflection of the squeegee over the full length of the squeegee blade.
3. If the deflection is not the same over the full length of the blade, turn the squeegee levelling nut to make adjustments.

DO NOT disconnect the suction hose from the squeegee frame when leveling squeegee.

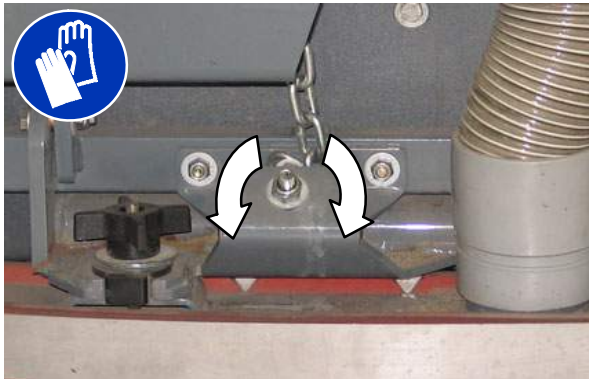

4. Turn the squeegee leveling nut counter-clockwise to decrease the deflection at the ends of the squeegee blade.

Turn the squeegee leveling nut clockwise to increase the deflection at the ends of the squeegee blade.

5. Drive the machine forward with the squeegee down to recheck the squeegee blade deflection if adjustments were made.
6. Readjust the squeegee blade deflection if necessary.

ADJUSTING THE REAR SQUEEGEE BLADE DEFLECTION

Deflection is the amount of curl the overall squeegee blade has when the machine moves forward. The best deflection is when the squeegee wipes the floor dry with a minimal amount of deflection.

NOTE: Make sure the squeegee is level before adjusting the deflection. See LEVELING THE REAR SQUEEGEE.

1. Lower the squeegee and drive the machine forward a few meters (feet).

FOR SAFETY: Before leaving or servicing machine, stop on level surface, set parking brake, turn off machine, and remove key.

2. Look at the amount of deflection or “curl” of the squeegee blade. The correct amount of deflection is 12 mm (0.50 in) for scrubbing smooth floors and 15 mm (0.62 in) for rough floors.

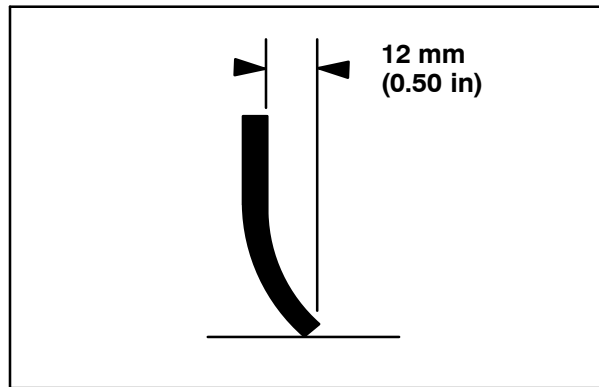

3. To adjust the overall squeegee blade deflection, turn the adjustment knobs counterclockwise to increase deflection or clockwise to decrease deflection.

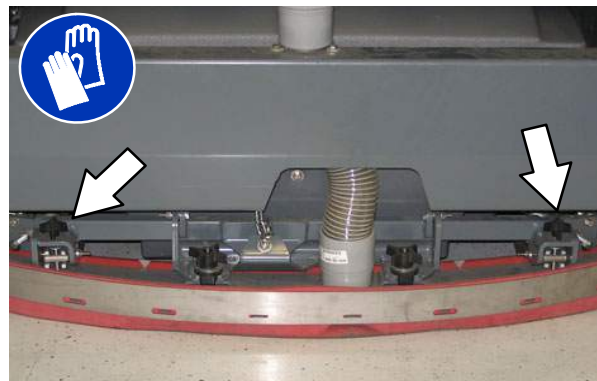

4. Drive the machine forward again to recheck the squeegee blade deflection after adjustments are made.
5. Readjust the squeegee blade deflection if necessary.

MAINTENANCE

SKIRTS AND SEALS

FOR SAFETY: Before leaving or servicing machine, stop on level surface, set parking brake, turn off machine, and remove key.

SCRUB HEAD SKIRT

Check the skirt for damage and wear after every 100 hours of operation.



The skirts should be between 0 to 6 mm (0 to 0.25 in) from the floor when the scrub head is down.

RECOVERY TANK SEAL

Check the recovery tank cover seal for damage and wear daily.



SOLUTION TANK SEALS

Check each solution tank cover seal for damage and wear daily.



BRAKES AND TIRES**BRAKES**

The mechanical brakes are located on the rear wheels. The brakes are operated by the foot brake pedal and connecting cables.

Check the brake adjustment after every 200 hours of operation.

To check the brake adjustment, measure the distance from the stationary brake pedal to the point where there is resistance in the pedal movement. The distance must be between 6 mm (0.25 in) and 19 mm (0.75 in). Adjust the brakes if required.

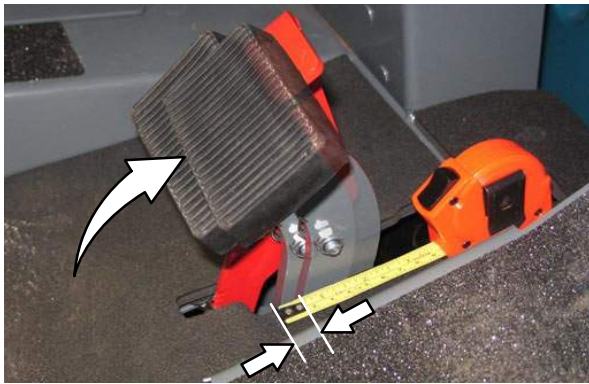
**TIRES**

Check tires for damage and wear after every 100 hours of operation.

FRONT WHEEL

Torque the front wheel nuts twice in the pattern shown to 122 to 149 Nm (90 to 110 ft lb) after the first 50 hours of operation, and after every 800 hours there after.

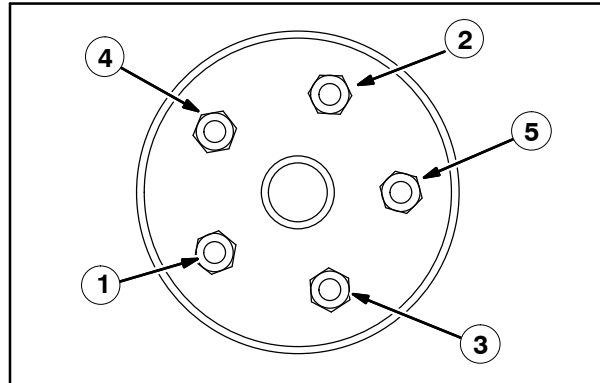
**PROPELLING MOTOR**

Torque the shaft nut to 508 Nm (375 ft lb) lubricated, 644 Nm (475 ft lb) dry, after every 800 hours of operation.

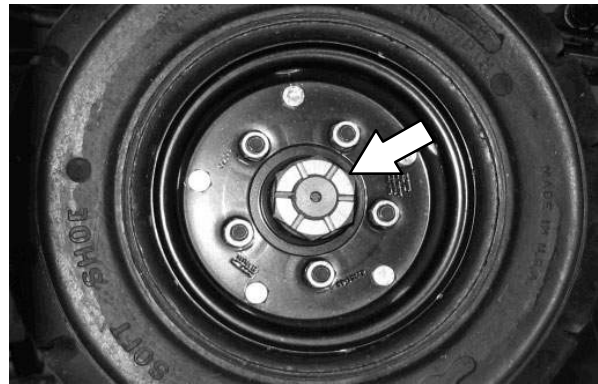

PUSHING, TOWING, AND TRANSPORTING THE MACHINE

PUSHING OR TOWING THE MACHINE

If the machine becomes disabled, it can be pushed from the front or rear, but only towed from the front.

The propelling pump has a bypass valve to prevent damage to the hydraulic system when the machine is being pushed or towed. This valve allows a disabled machine to be moved for a *very short distance* and at a speed to not exceed 1.6 kp/h (1 mph). The machine is NOT intended to be pushed or towed a long distance or at a high speed.

ATTENTION! Do not push or tow machine for a long distance or damage may occur to the propelling system.

Turn the bypass valve located on the bottom of the propelling pump 90° (either direction) from the normal position before pushing or towing the machine. Return the bypass valve back to the normal position when through pushing or towing the machine. **Do Not** use the bypass valve during normal machine operation.

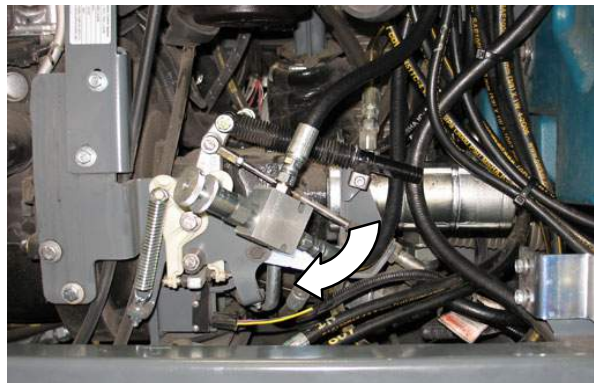
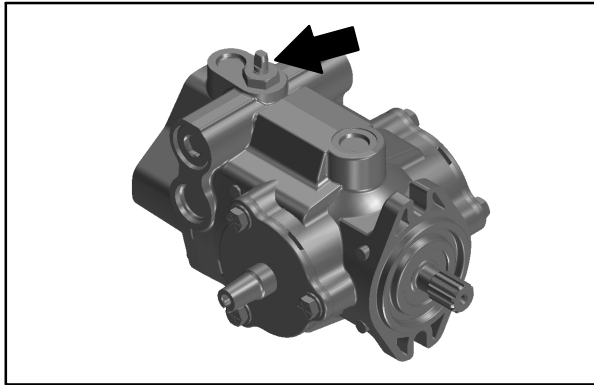

TRANSPORTING THE MACHINE

1. Raise the squeegee, scrub head, and brushes. If necessary, raise the hopper for additional ramp clearance.

FOR SAFETY: When loading machine onto truck or trailer, drain tanks and empty hopper before loading machine.

NOTE The machine ability to climb a ramp is affected by tire wear, ramp surface, weather conditions, and other factors. Trailing should only be performed by personnel trained on how to safely load a machine.

2. Drive the machine onto the trailer or truck. Position the machine so the weight of the machine is safely distributed and can be safely strapped down to the trailer or truck.

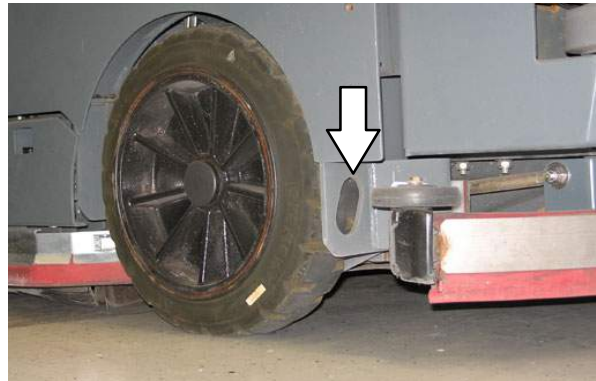

3. Set the parking brake and place a block behind each wheel to prevent the machine from rolling.
4. Lower the scrub head.

FOR SAFETY: When loading/unloading machine onto/off truck or trailer, lower scrub head and squeegee before tying down machine.

5. Connect the tie-down straps to the holes in the right and left lower corners in front of the machine and the holes in the rear jacking brackets behind the rear tires.

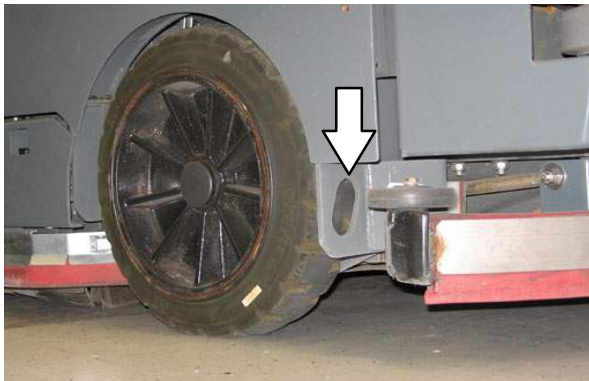
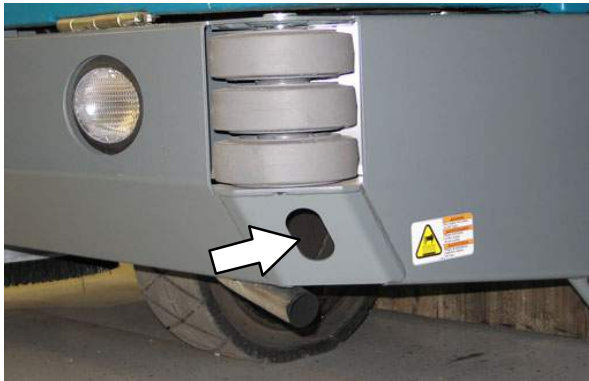

6. Route the tie-downs to the opposite ends of the machine and hook them to the brackets on the floor of the trailer or truck. Tighten the tie-down straps.

NOTE: It may be necessary to install tie-down brackets to the floor of the trailer or truck.

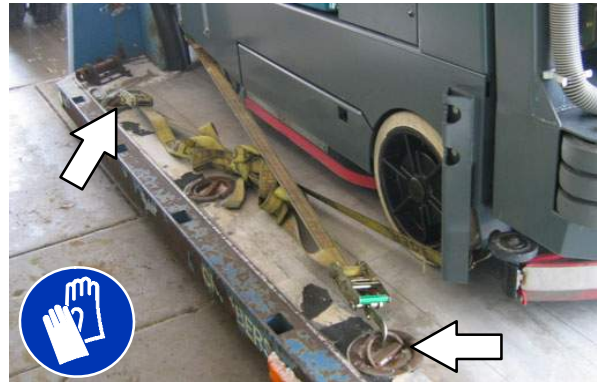

MAINTENANCE

MACHINE JACKING

Empty the hopper, recovery tank, and solution tank before jacking up the machine. Jack up the machine at the designated locations. Use a hoist or jack capable of supporting the weight of the machine. Use jackstands to support the machine. Always stop the machine on a flat, level surface and block the tires before jacking up the machine.

Rear jacking locations are located directly behind the rear tires on each side of the machine.

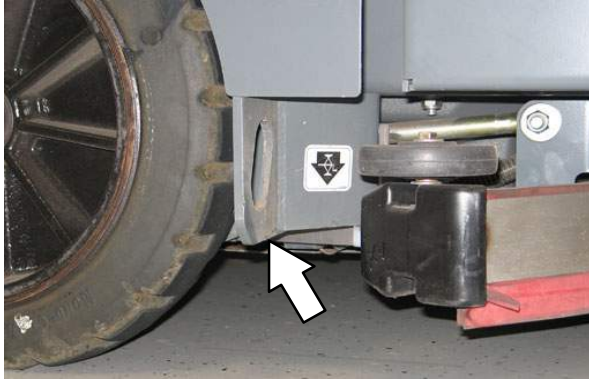

Front jacking locations are located on the frame directly in front of the front tire.

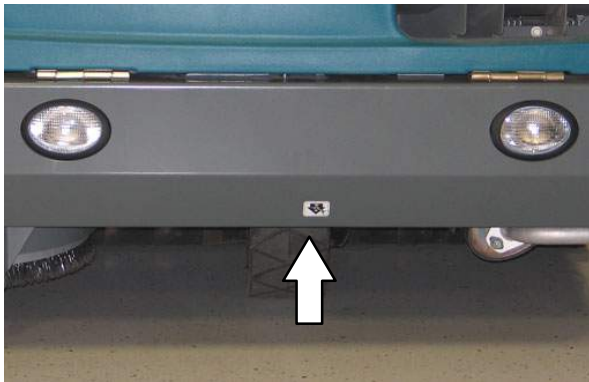

FOR SAFETY: Before leaving or servicing machine, stop on level surface, set parking brake, turn off machine, and remove key.

FOR SAFETY: When servicing machine, block machine tires before jacking machine up. Use a hoist or jack that will support the weight of the machine. Jack machine up at designated locations only. Support machine with jack stands.

STORAGE INFORMATION

The following steps should be taken prior to storing the machine for extended periods.

1. Drain and clean the solution and recovery tanks. Open the recovery tank and solution tank covers to allow the air to circulate.
2. Park the machine in a cool, dry area. Do not expose the machine to rain. Store indoors.
3. Remove the battery, or charge battery every three months.

FREEZE PROTECTION (MACHINES WITHOUT ec-H₂O SYSTEM)

FOR SAFETY: Before leaving or servicing machine, stop on level surface, set parking brake, and turn off machine.

1. Be sure the solution tank and recovery tank are empty.
2. Pour 3.8 L (1 gal) of Propylene Glycol Based / Recreational Vehicle (RV) Antifreeze into the solution tank.
3. Turn the key to the on position (**without starting the machine**).
4. Press the *scrubbing main brush button*.
5. Press the *1-STEP button*.
6. Repeatedly press the *Solution increase button (+)* until the solution flow is at the highest setting.
7. Press the *directional pedal* to circulate the RV antifreeze completely through the system.
8. Press the *1-STEP button* to turn off the system.
9. **Machines equipped with the optional spray nozzle only:** Turn on the pump until RV antifreeze solution sprays from the nozzle.
10. Turn the key to the off position.
11. The remaining RV antifreeze does not need to be drained from the solution tank.

NOTE: Storing or transporting machines equipped with the ES or the FaST system in freezing temperatures requires special procedures. Consult a TENNANT representative for more information.

FREEZE PROTECTION (MACHINES WITH ec-H₂O SYSTEM)

FOR SAFETY: Before leaving or servicing machine, stop on level surface, set parking brake, and turn off machine.

1. Empty the solution tank and recovery tank.
2. Remove the intake flush hose and from the storage bag behind the operator seat.
3. Disconnect the *ec-H₂O* system intake hose from the solution supply hose and connect the intake flush hose (gray connector) to the *ec-H₂O* system intake hose.



4. Pull the drain tube from the between the ec-H₂O unit and the operator compartment, remove the cap from the tube, and place the end of the tube into an empty container. Set the cap aside.



MAINTENANCE

5. Turn the key to the on position (**without starting the machine**).
6. Press and release the *ec-H2O* module flush switch. Allow the system to drain water into the container for 2 minutes.

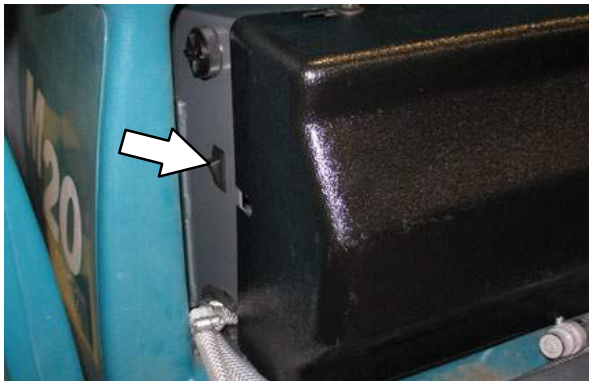

7. Press the *ec-H2O* module flush switch to shut off the system.
8. Disconnect the *ec-H2O* system outlet hose from the hose to the scrub head.



9. Blow pressurized air (less than 344 kPa (50 psi)) into the *ec-H2O* system outlet hose. Continue blowing compressed air into the outlet hose until water no longer drains from the drain tube.

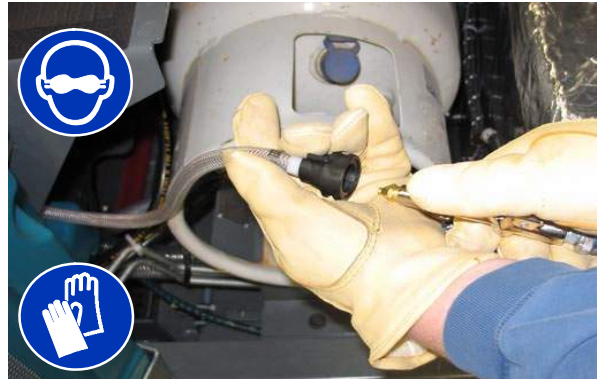

10. Reinstall the cap onto the drain tube and insert the tube back between the *ec-H2O* module and the operator compartment.
11. Reconnect the *ec-H2O* system intake hose to the solution supply hose and the *ec-H2O* system outlet hose to the hose to the scrub head.
12. Return the intake flush hose to the storage bag behind the operator seat.

PRIMING THE *ec-H2O* SYSTEM

Prime the *ec-H2O* system if the machine has been stored for a long period without water in the solution tank / *ec-H2O* system.

FOR SAFETY: Before leaving or servicing machine, stop on level surface, set parking brake, and turn off machine.

1. Fill the solution tank with clean cool water.
See *FILLING THE SOLUTION TANK* section of this manual.
2. Remove the outlet flush hose (black connector) from the storage bag behind the operator seat.
3. Disconnect the *ec-H2O* system outlet hose from the hose to the scrub head and connect the outlet flush hose to the *ec-H2O* system outlet hose.



4. Place the *ec-H2O* system outlet hose into an empty container.
5. Turn the key to the on position (**without starting the machine**).
6. Press and release the *ec-H2O* module flush switch. Allow the system to drain water into the container for 2 minutes.
7. Press the *ec-H2O* module flush switch to shut off the system.
8. Disconnect the outlet flush hose from the *ec-H2O* system outlet hose and return the flush hose to the storage bag.
9. Reconnect the *ec-H2O* system outlet hose to the hose to the scrub head.

SPECIFICATIONS

SPECIFICATIONS

GENERAL MACHINE DIMENSIONS/CAPACITIES

Item	Dimension/Capacity
Length	2745 mm (108 in)
Height	1475 mm (58 in)
Height (with overhead guard)	2135 mm (84 in)
Width/frame (roller to roller)	1475 mm (58 in)
Width (rear squeegee)	1500 mm (59 in)
Width (with side brush)	1625 mm (64 in)
Wheel base	1422 mm (56 in)
Track	1473 mm (58 in)
Cleaning path width (Main brush length)	1220 mm (48 in)
Cleaning path width (with scrubbing side brush)	1575 mm (62 in)
Cleaning path width (with sweeping side brush)	1625 mm (64 in)
Main brush diameter (2)	305 mm (12 in)
Side brush diameter (scrubbing)	410 mm (16 in)
Side brush diameter (sweeping)	535 mm (21 in)
Solution tank capacity	284 L (75 gallons)
Recovery tank capacity	360 L (95 gallons)
Debris hopper volume capacity	198 L (7.0 ft ³)
Debris hopper weight capacity	295 kg (650 lbs)
Dump height (variable to)	1525 mm (60 in)
Minimum ceiling dump height	2620 mm (103 in)
Weight – empty	1815 Kg (4000 lbs)
GVWR	2449 Kg (5400 lbs)
Transport ground clearance	80 mm (3 in)
Protection Grade	IPX3

Values determined as per IEC 60335-2-72	Measure
Sound pressure level L_{pA}	84 dB(A)
Sound uncertainty K_{pA}	3.0 dB(A)
Sound power level L_{WA} + Uncertainty K_{WA}	106 dB(A)
Vibration – Hand–arm	< 2.5 m/s ²
Vibration – Whole body	< 0.5 m/s ²

GENERAL MACHINE PERFORMANCE

Item	Measure
Minimum aisle turn	3175 mm (125 in)
Travel speed forward (maximum)	12.9 Km/h (8 mph)
Travel speed reverse (maximum)	4.8 Km/h (3 mph)
Maximum ramp incline for loading – Empty tanks	10.0 deg/18%
Maximum ramp incline for scrubbing	6.0 deg/10%
Maximum ramp incline for transporting (GVWR)	8.0 deg/14%
Maximum ambient temperature for machine operation	43° C (110° F)
Minimum temperature for operating machine scrubbing functions	0° C (32° F)

HYDRAULIC SYSTEM

System	Capacity	ISO Grade Viscosity Index	Ambient Air Temperature Ranges
Hydraulic reservoir	38 L (10 gal)	ISO 100 VI 126 or higher	19° C (65° F) or higher
Hydraulic total	45 L (12 gal)	ISO 68 VI 155 or higher	7 to 43° C (45 to 110° F)
		ISO 32 VI 163 or higher	16° C (60° F) or lower

POWER TYPE

Engine	Type	Ignition	Cycle	Aspiration	Cylinders	Bore	Stroke
Mitsubishi 2.0	Piston	Coil @ Plug	4	Natural	4	85 mm (3.35 in)	88 mm (3.46 in)
	Displacement		Tennant governed power			Gross intermittent power per SAE J 1995	
	2.0 L (122 cu in)		Gasoline: 30.3 kw (40.6 hp) @ 2300 rpm			37.8 kw (50.7 hp) @ 2800 rpm	
			LPG: 31.6 kw (42.4 hp) @ 2300 rpm			38.5 kw (51.6 hp) @ 2800 rpm	
	Fuel		Cooling system			Electrical system	
	Gasoline, 87 octane minimum, unleaded Fuel tank: 42 L (11.2 gal)		Water/ethylene glycol antifreeze			12 V nominal	
	LPG, Fuel tank: 15 kg (33 lb)		Total: 7.5 L (2 gal) Radiator: 3.8 L (1 gal)			75 A alternator	
	Idle speed, no load		(Fast) governed speed, under load			Firing order	
	1350 ± 50 rpm		2300 ± 50 rpm			1-3-4-2	
	Spark plug gap		Valve clearance, cold			Engine lubricating oil with filter	
1.1 mm (0.043 in)		No Adjustment OHC Engine			4.7 L (5 qt) 5W30 SAE-SG/SH		

BRAKING SYSTEM

Type	Operation
Service brakes	Mechanical drum brakes (2), one per rear wheel, cable actuated
Parking brake	Utilize service brakes, cable actuated

TIRES

Location	Type	Size
Front (1)	Solid	150 mm x 460 mm (6 in x 18 in)
Rear (2)	Solid	127 mm x 460 mm (5 in x 18 in)

STEERING

Type	Power source
Front wheel, hydraulic cylinder and rotary valve controlled	Hydraulic accessory pump

SPECIFICATIONS

FaST SYSTEM

Item	Measure
Solution pump	12 Volt DC, 11A, 0.7 GPM & 1.4 GPM flow (2 speed), 75 psi high-pressure shutdown
Low solution flow rate	2.7 LPM (0.7 GPM)
High solution flow rate	5.4 LPM (1.4 GPM)
Low concentrate flow rate	2.6 CC/Minute (0.085 Liquid Ounces/Minute)
High concentrate flow rate	5.2 CC/Minute (0.17 Liquid Ounces/Minute)

ec-H2O SYSTEM

Item	Measure
Solution pump	12 Volt DC, 11A, 0.7 GPM & 1.4 GPM flow, (2 speeds), 75 psi high-pressure shutdown
Solution flow rate	2.65 LPM (0.7 GPM) – Low
	5.30 LPM (1.4 GPM) – High

MACHINE DIMENSIONS

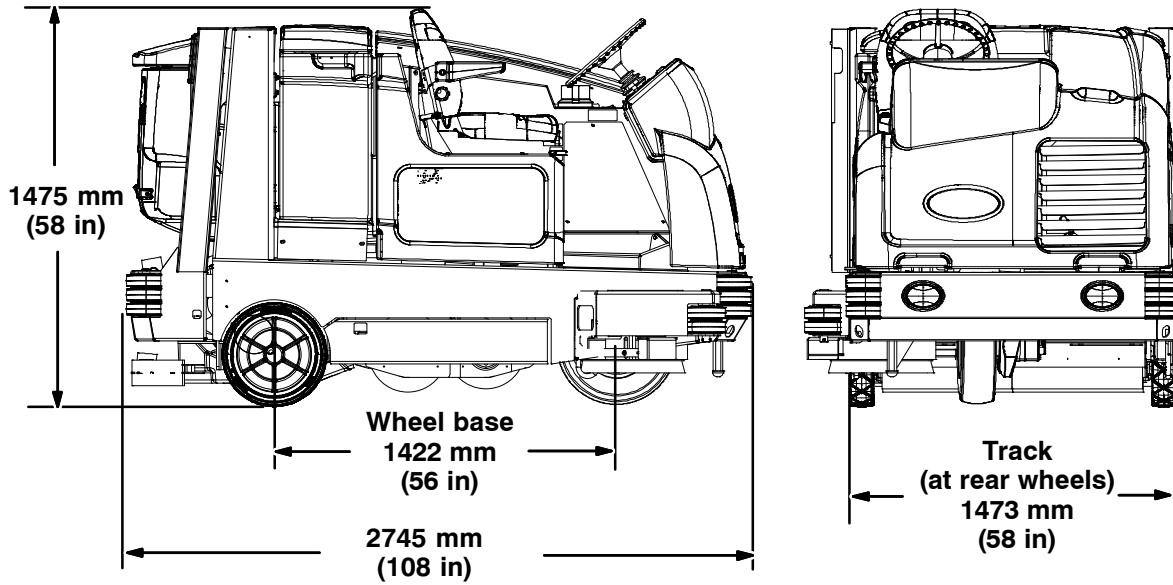
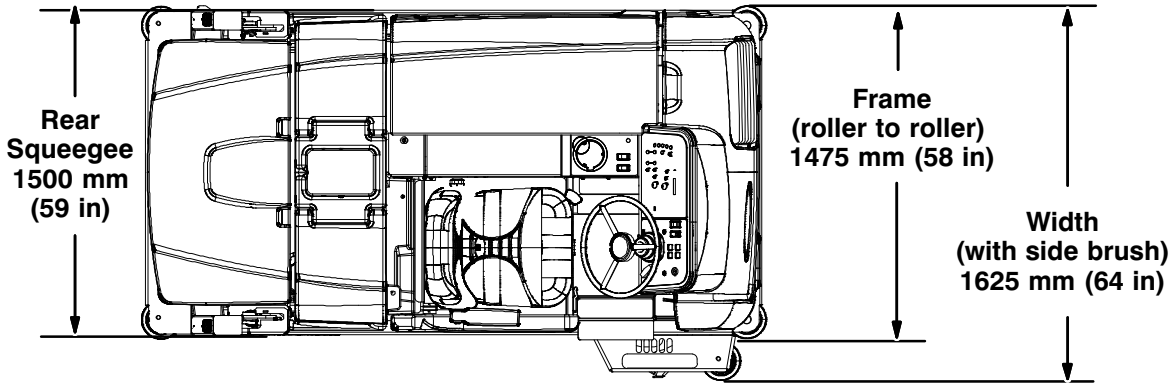

1014751

SUPERVISOR CONTROLS

PRO-PANEL SUPERVISOR CONTROLS

The supervisor controls feature allows a supervisor to program the machine scrubbing settings for operator use. The lockout functionality will prevent the operator from changing or saving the settings.

The supervisor controls feature will lower machine variability for consistent, repeatable cleaning results, machine quality assurance regardless of user experience, and reduce user training requirements.

There are two types of user modes that will interface with the operator home screen:

Operator Mode – Capable of machine operation with permissions and restrictions controlled by the supervisor.

Supervisor Mode – Capable of machine operation with full use of all controls, along with configuring permissions and restrictions for the operator mode.

A new machine from the factory will automatically start in the supervisor mode with a preassigned default supervisor profile. The factory-assigned supervisor login number is “1234”. This login number is not required until it is enabled. The default supervisor profile name and login number can be changed as described in this section. If the new assigned supervisor mode login number is forgotten, please contact Tennant service.

ENTERING THE SUPERVISOR MODE – FIRST TIME USE ONLY

1. Turn on the machine. The main operating screen will appear in the display.
2. Press the help button to access the help screen.

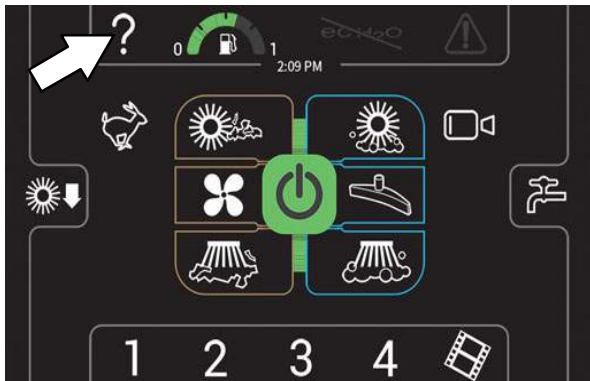

3. Press the logout button.

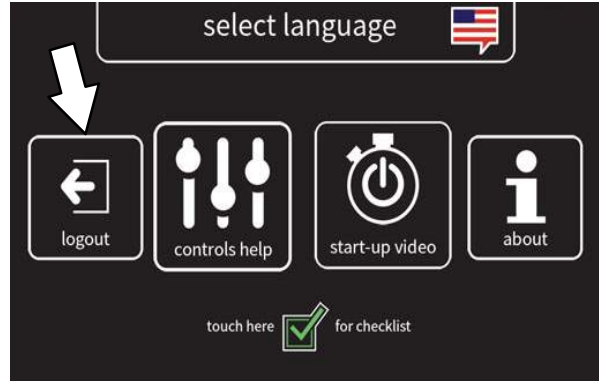

4. Use the keypad to enter the factory assigned supervisor login number 1234 into the display above the keypad. Press the enter button when finished entering the supervisor login number.

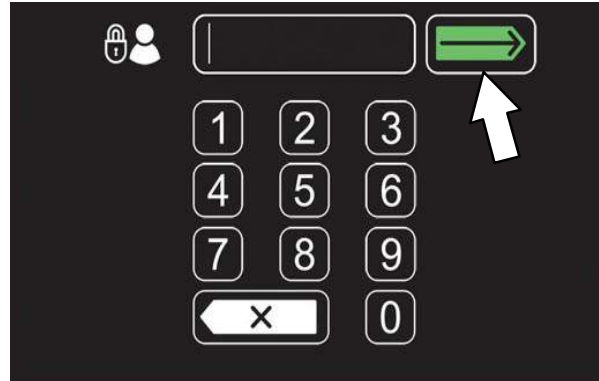

 Press the backspace button if necessary to delete and reenter a number.

5. The supervisor machine operation screen should appear in the display. Press the settings button to access the supervisor settings screen.

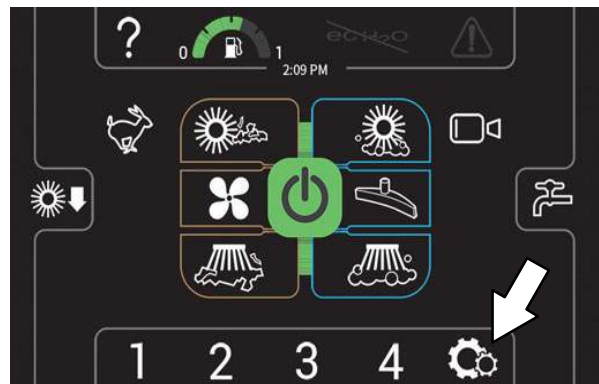

6. Proceed to *ADDING / EDITING PROFILES*.

ENTERING THE SUPERVISOR MODE

1. Turn on the machine. The login screen will appear on the display.
2. Use the keypad to enter the supervisor login number into the display above the keypad. Press the enter button when finished entering the supervisor login number.

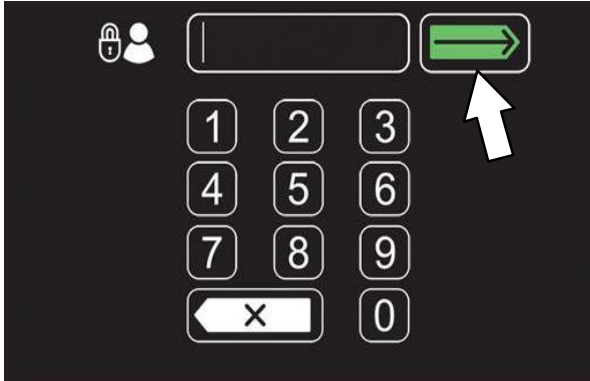

 Press the backspace button if necessary to delete and reenter a number.

3. The supervisor machine operation screen should appear in the display. Press the settings button to access the supervisor settings screen.

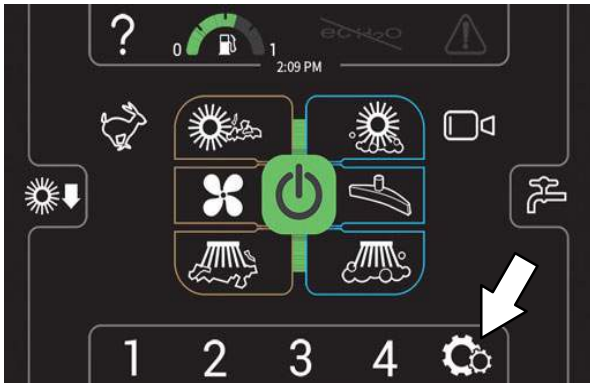

SUPERVISOR CONTROLS

SUPERVISOR SETTING SCREEN / SCREEN ICONS

Use the supervisor maintenance screen to setup / change user passwords, user machine settings, and other machine setup items.

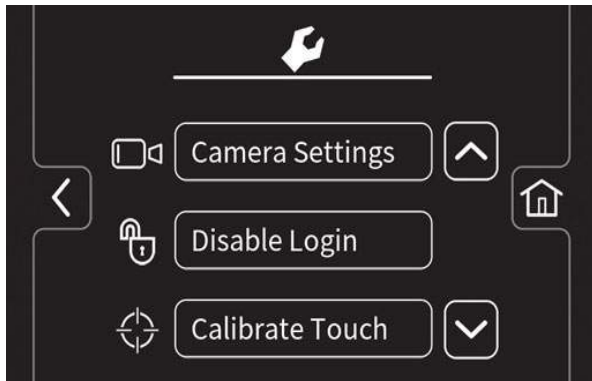
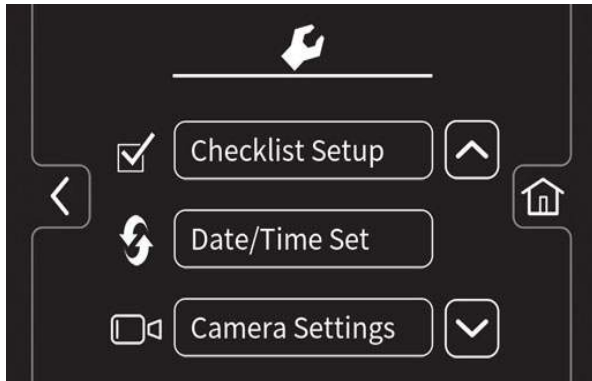
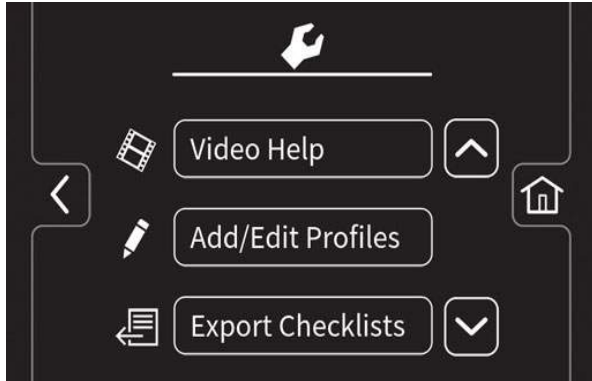

Use the below menu buttons to access the various supervisor setup menus / screens.



Press the video help button to access the various machine help videos.



Press the Add / Edit Profiles button to add, delete, and / or change machine user and supervisor profiles. See *ADDING / EDITING PROFILES*.



Press the Export Checklists button to access the Export Checklists menu. See *EXPORTING CHECKLISTS*.



Press the Checklists Setup button to access the Checklist Setup menu. See *DISABLING / ENABLING THE PREOPERATION CHECKLIST*.



Press the Date / Time Set button to set the machine date and time. See *SETTING / CHANGING THE DATE AND TIME*.



Press the Camera Settings button to access the Camera Settings screen. See *CHANGING REARVIEW CAMERA SETTINGS*.



Press the Enable Login button to activate a required login number at machine start up for all user profiles to operate machine.



Press the Disable Login button to deactivate a login number at machine start up for all user profiles to operate machine. See *DISABLING LOGIN*.



Press the Calibrate Touch button to calibrate the touch screen if the touch points become misaligned.



Press the up arrow button to navigate up through the menu items.



Press the down arrow button to navigate down through the menu items.



Press the home button to navigate back to the main operating screen.



Press the back button to navigate back to the previous screen.





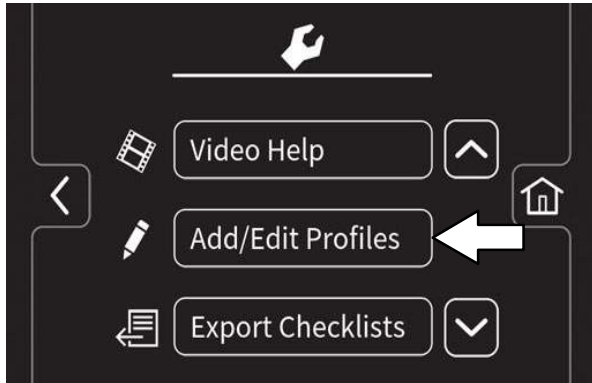

ADDING / EDITING PROFILES

1. Turn on the machine, log into the supervisor screen, and press the settings button to access the supervisor settings screen. See *ENTERING THE SUPERVISOR MODE*.
2. Press the Add/Edit Profiles button to access the Add/Edit Profiles screen.



3. Press the Add Profile button to access the Add Profile screen.



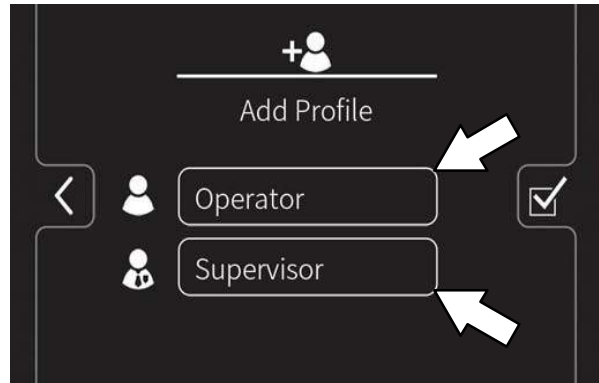

-  Press the Add Profile button to access the screens and menus to add a new profile.
-  Press the Edit Profile button to edit an existing profile.
-  Press the Copy Profile button to copy an existing profile.
-  Press the Delete Profile button to delete an existing profile.
-  Press the home button to navigate back to the main operating screen.
-  Press the back button to navigate back to the previous screen.

4. Press the Operator button to add a new operator, or Supervisor button to add a new supervisor.



NOTE: The default supervisor cannot be deleted from the profile list.

-  Press the Operator button to add / edit / copy / delete an operator profile.
-  Press the Supervisor button to add / edit / copy / delete a supervisor profile.

5. Use the keypad to enter the new user / supervisor name. Press the enter button.



SUPERVISOR CONTROLS

- Use the keypad to assign the new user / supervisor a login number. The new login number can be any combination of numbers ranging from 3 to 8 digits in length. Press the enter button.

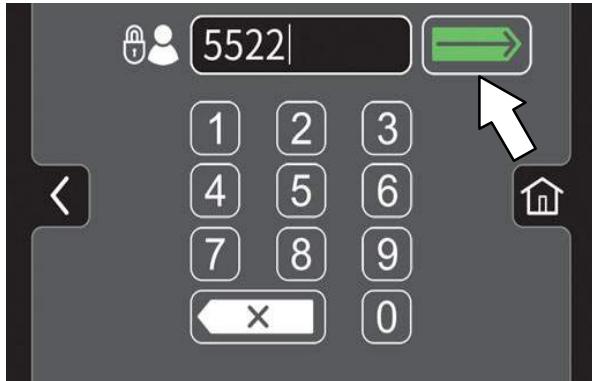



 Press the backspace button if necessary to delete and reenter a number.

- Select the controls the new user should have access to use. Green represents unlocked controls and gray represents locked controls. Press the flashing save button to save the new profile.

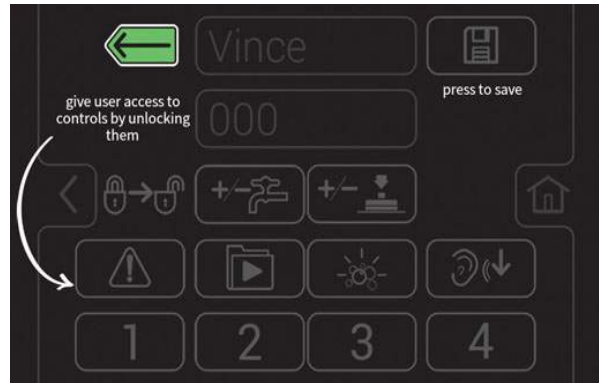

 Press the help button to access the help screen.



 Press the back button to return to the user access page.

- The new user profile is now saved to the operator profile list. Multiple operator and supervisor user profiles can be added. Press the back arrow button to return to the previous screen to add more user profiles or to enable login.
- To enable the login number at start up, press the Enable Login button.

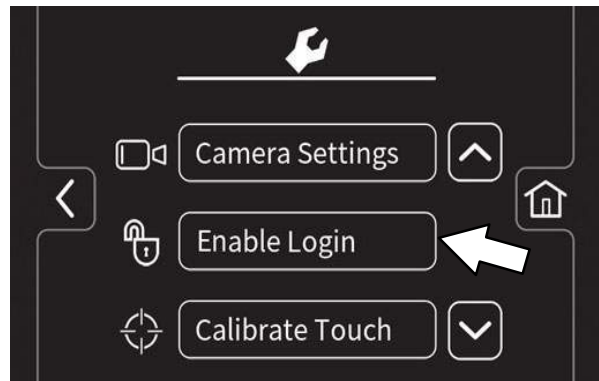

The Enable Login button will change from Enable Login to Disable Login. See *DISABLING LOGIN* for instructions how to disable login.

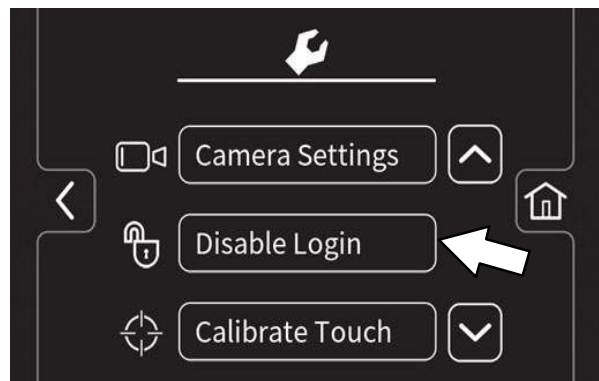

10. Now at machine start up, a login screen will display. The new user will need to enter their assigned login number to operate machine.
11. When the user is done operating the machine, it is recommended the user log out by pressing the help button, and then pressing the logout button. Turning the key to the off position is another way to also logout.
12. Use the Edit Profile button, Copy Profile button, and Delete Profile button to manage the current user profiles.

ENABLING THE LOGIN

1. Turn on the machine, log into the supervisor screen, and press the settings button to access the supervisor settings screen. See *ENTERING THE SUPERVISOR MODE*
2. Press the Enable Login button.

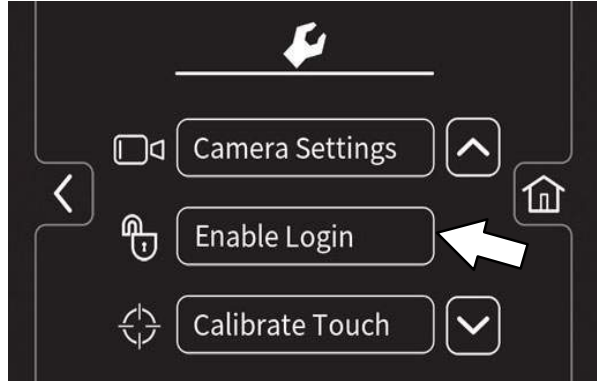

3. Press the yes button to enter the Default User screen.



4. Press either the Operator button or Supervisor button to select the desired default user.

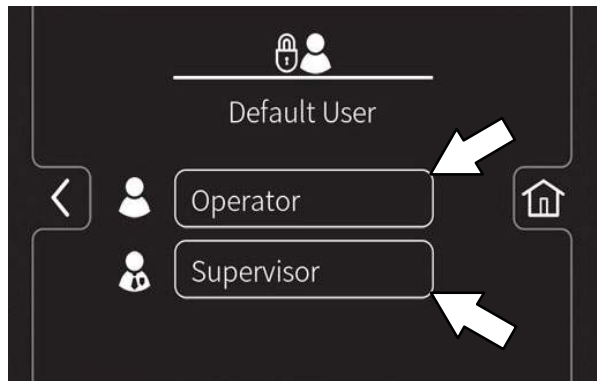

SUPERVISOR CONTROLS

DISABLING THE LOGIN

1. Turn on the machine, log into the supervisor screen, and press the settings button to access the supervisor settings screen. See *ENTERING THE SUPERVISOR MODE*
2. Press the Disable Login button.

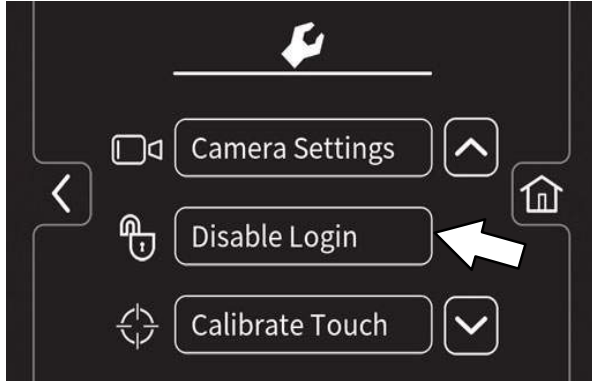

3. Press the yes button to enter the Default User screen.



4. Press either the Operator button or Supervisor button to select the desired default user.

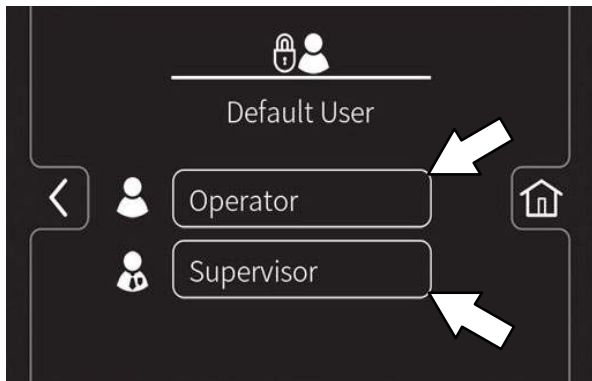

5. Select a pre-assigned user profile. Turn off the machine to apply the setting.

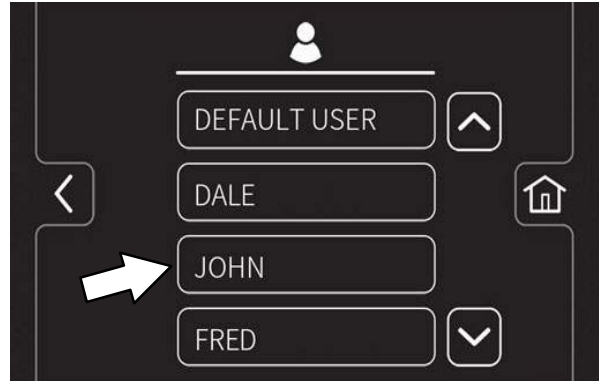

6. At start up, the home screen is now set without a login requirement for the operator profile as the default.

CALIBRATING THE TOUCH

1. Turn on the machine, login to the main operation screen, and press the setting button to access the supervisor settings screen. See *ENTERING THE SUPERVISOR MODE*
2. Press the Calibrate Touch button to recalibrate touch if the touch points become misaligned.

EXPORTING CHECKLISTS

Exporting the checklists allows the checklists to be exported from the machine and to a flash drive.

1. Turn on the machine, log into the supervisor screen, and press the settings button to access the supervisor settings screen. See *ENTERING THE SUPERVISOR MODE*
2. Plug the flash drive into the USB port.



3. Press the Export Checklists button to access the export screen.

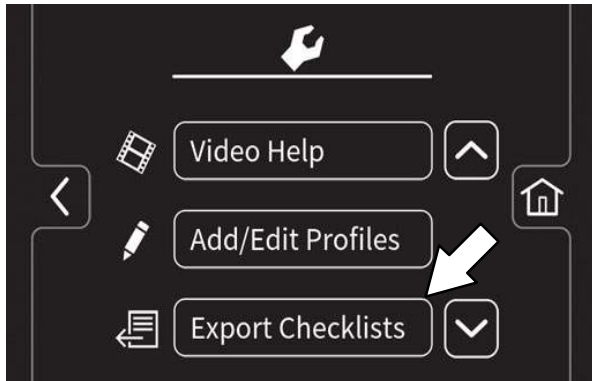

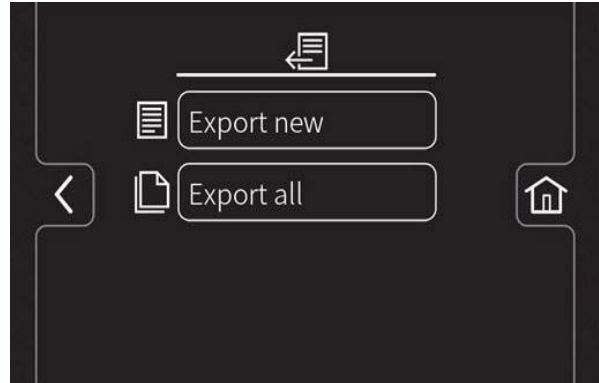

4. Export the Pre-Operation Checklists from the machine to the memory stick.



 Press the Export New button to export the newly completed Pre-Operation Checklists from the machine.

NOTE: All checklists that have not been previously exported are flagged.

 Press the Export All button to export all completed Pre-Operation Checklists from the machine.

 Press the home button to navigate back to the main operating screen.

 Press the back button to navigate back to the previous screen.

5. Remove the flash drive from USB port and turn off the machine.

SUPERVISOR CONTROLS

CHECKLIST SETUP

Checklist setup allows the checklist to be setup / changed to meet machine usage demands.

1. Turn on the machine, login to the main operation screen, and press the setting button to access the supervisor settings screen. See *ENTERING THE SUPERVISOR MODE*.
2. Press the Checklist Setup button to access the Pre-Operation checklist setup screen.

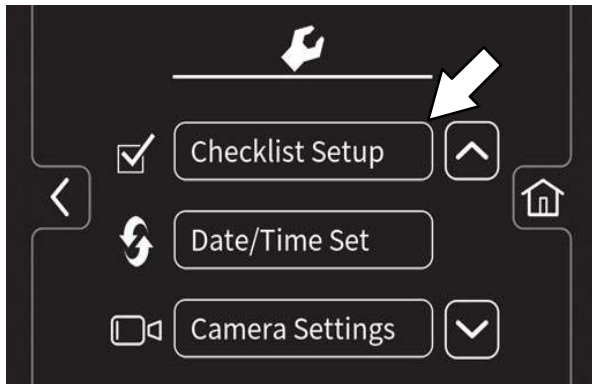

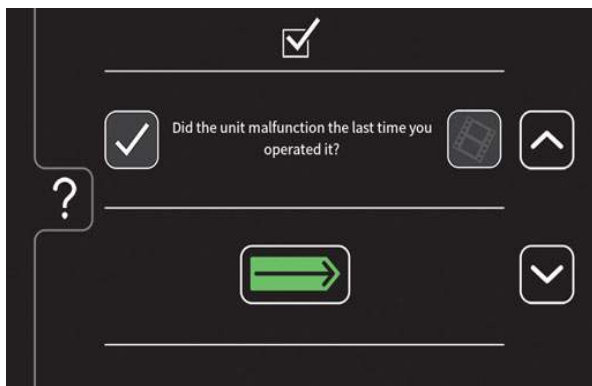
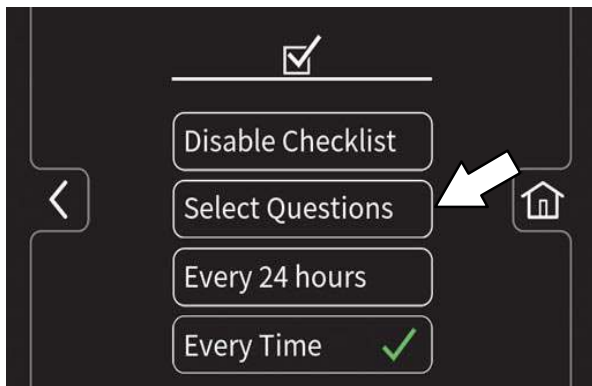

3. Press the Select Questions button to access the Pre-Operation Checklist master list screen.





 Press the down arrow button to scroll down through Pre-Operation Checklist items.

 Press the up arrow button to scroll up through Pre-Operation Checklist items.

 Press the check box button to select a new checklist item to add to the checklist.

 Press either the video help button to view the video related to a particular Pre-Operation Checklist item.

 Press the Enter button to add the selected Pre-Operation Checklist item(s) to the Pre-Operation Checklist.

 Press the help button to access the Pre-Operation Checklist help screen.

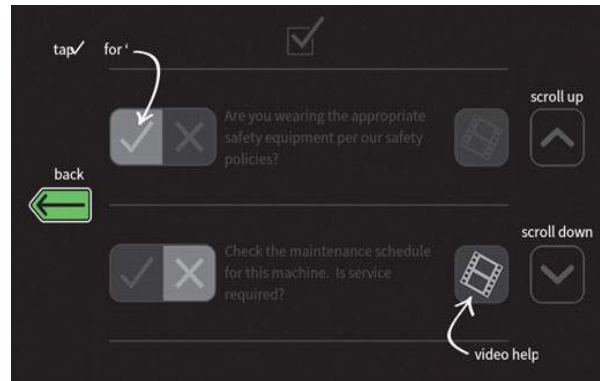

 Press the back button to return to the Pre-Operation Checklist Master List screen.

4. Press the Every 12 hours button or the Every Time button to set the interval the operator must complete the Pre-Operation Checklist. A check mark appears in the chosen interval.

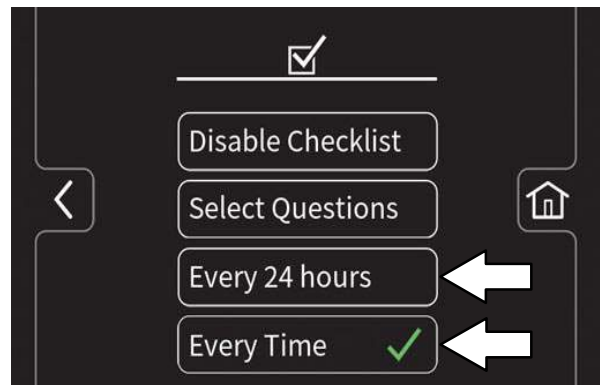

 Press the home button to navigate back to the main operating screen.

 Press the back button to navigate back to the previous screen.

DISABLING / ENABLING THE PRE-OPERATION CHECKLIST

Disabling / enabling the Pre-Operation checklist allows the Pre-Operation checklist to be disabled if it is not necessary for the operator to complete the checklist prior to operating the machine and enabled if it is necessary for the operator to complete the checklist prior to operating the machine.

1. Turn on the machine, login to the main operation screen, and press the setting button to access the supervisor settings screen. See *ENTERING THE SUPERVISOR MODE*.
2. Press the Checklist Setup button to access the Pre-Operation checklist setup screen.

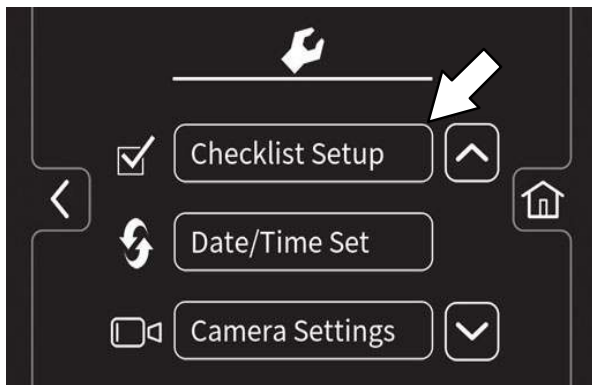

3. Press the Disable Checklist button / Enable Checklist button to disable / enable the Pre-Operation Checklist.

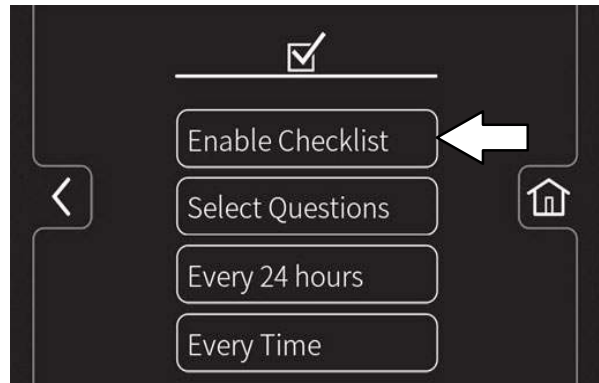
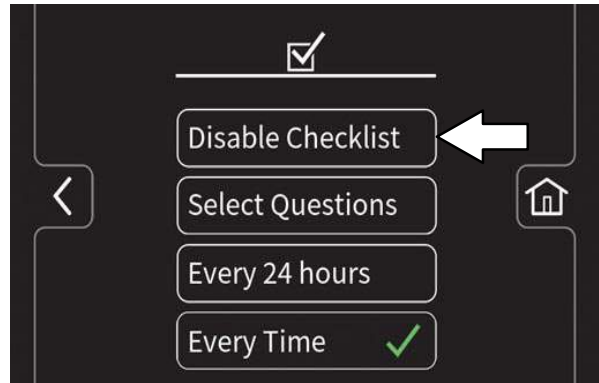

 Press the home button to navigate back to the main operating screen.

 Press the back button to navigate back to the previous screen.





SUPERVISOR CONTROLS

CHANGING THE REAR VIEW CAMERA SETTINGS

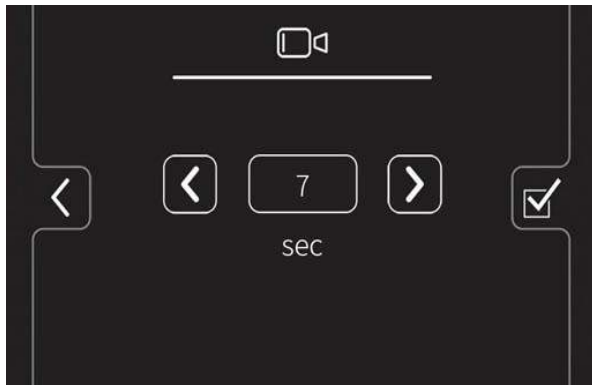
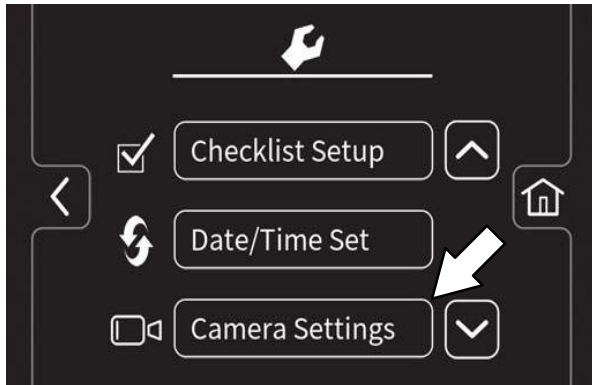
Changing the rear view camera settings allows the time the rear view camera remains on when the *rear view camera button* is pushed to be changed. The rear view camera can be set to any time between 5 seconds and 15 seconds.

1. Turn on the machine, log into the main operation screen, and press the setting button to access the supervisor settings screen. See *ENTERING THE SUPERVISOR MODE*.
2. Press the *Camera Settings button* to access the rear view camera settings screen.



-  Press the *increase button* to increase the time the rear view camera remains on when the operator presses the *rearview camera button*.
-  Press the *decrease button* to decrease the time the rear view camera remains on when the operator presses the *rearview camera button*.
-  Press the home button to navigate back to the main operating screen.
-  Press the back button to navigate back to the previous screen.

PROGRAMMING THE ZONE CONTROL BUTTONS

Programming the zone control buttons allows the parameters for the zone control buttons to be changed / updated to meet scrubbing / sweeping demands.

1. Turn on the machine, log into the supervisor screen, and press the setting button to access the supervisor settings screen. See *ENTERING THE SUPERVISOR MODE*.
2. Use the *brush pressure increase (+) button* and the *brush pressure decrease (-) button* to set the zone brush pressure.



3. Use the *solution increase (+) button* and the *solution decrease (-) button* to set the zone solution flow level.



4. Press and hold the zone control button until the “name preset” screen appears.

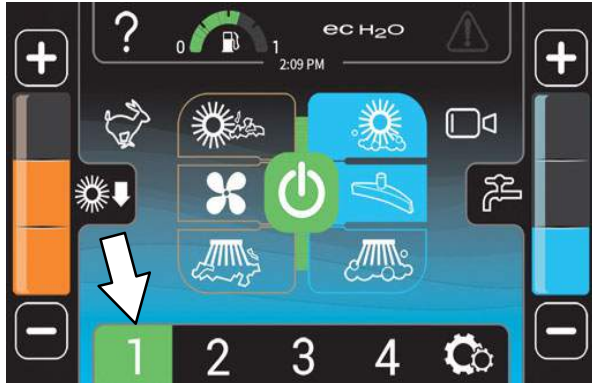







5. Press the yes button to set the zone settings. Press the no button to return to the main operating screen.



6. Use the key pad to enter the name for the zone control button.



-  Press the home button to navigate back to the main operating screen.
-  Press the back button to navigate back to the previous screen.
-  Press the enter button to set the zone button name.
-  Press the backspace button if necessary to delete and reenter a number.
-  Press the space button to place space between letters / numbers..
-  Press the pound button to toggle between the number keypad and the letter keypad.

SUPERVISOR CONTROLS

- Press the enter button to set the zone button settings. The main operating screen returns to the display with the zone button named. The brush pressure and solution flow setting also briefly appear in the display.







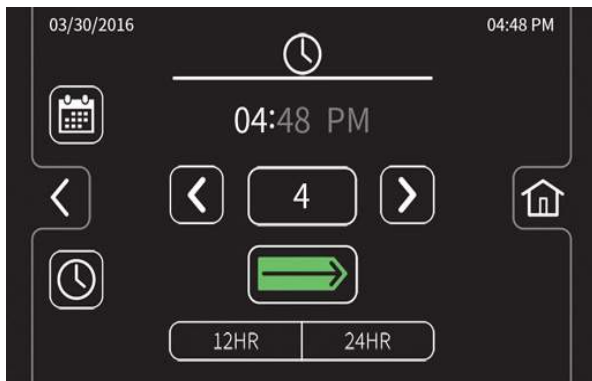
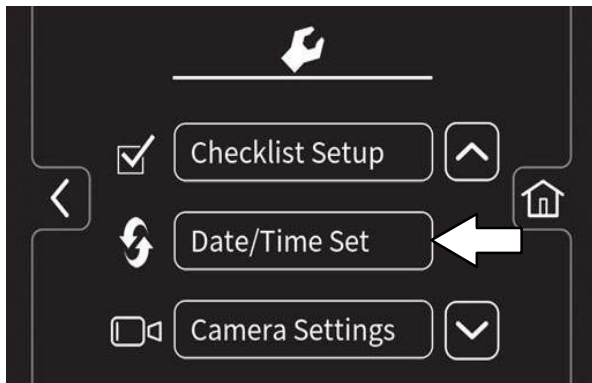

SETTING / CHANGING THE DATE AND TIME

Setting / changing the date and time allow the system date and time to be set / changed.

- Turn on the machine, login to the main operation screen, and press the setting button to access the supervisor settings screen. See *ENTERING THE SUPERVISOR MODE*
- Press the *Date/Time Set button* to access the date / time screen.



-  Press the *date button* to change the system date
-  Press the *time button* to change the system time.
-  Press the *toggle button* to toggle between hours, minutes, and AM / PM on the time screen and the month, day, and year on the date screen.
-  Press the *increase button* advance the time / date parameters
-  Press the *decrease button* to reverse the time / date parameters.
-  Press the home button to navigate back to the main operating screen.
-  Press the back button to navigate back to the previous screen.

1

- 1–STEP button – Pro–Panel, 19
- 1–STEP button – Standard panel, 15
- 1–STEP Scrub button, 38, 44
- 1–STEP Sweep button, 31

A

- Adding / Editing Profiles, 103
- Adjust operator seat, 29
- Adjust steering column, 29
- Adjusting the Main Brush Taper, 78
- Adjusting the Main Brush Width, 78
- Adjusting the Rear Squeegee Blade Deflection, 87
- Air Filter, 72
- Alarms, 56
 - Fault Indicators, 56

B

- Battery, 73
- Belts, Camshaft and Balance, 73
- Brake pedal, 29
- Brakes, 89
 - System specifications, 97
- Brakes and Tires, 89
 - Brakes, 89
 - Front Wheel, 89
 - Tires, 89
- Brush Information, 32
- Brush pressure button – Pro–Panel, 40, 41
- Brush pressure button – Standard panel, 40
- Buttons
 - Filter shaker button, 48
 - Hopper door open/close button, 48
 - Hopper raise/lower button, 48
 - Scrub vacuum fan/squeegee button, 44
- Buttons, Controls and Instruments, 9, 10
- Bypass valve, 90

C

- Calibrating the Touch, 106
- Camshaft and Balance Shaft Belts, 73
- Capacities, 96
- Changing the default button – Pro–panel, 19
- Changing the LPG Tank, 34
- Changing the Rear View Camera Settings, 110
- Checking the Main Brush Pattern, 77
- Checklist Setup, 108
- Cleaning the ec–H2O filter screen, 82
- Cleaning the FaST Supply Hose Connector, 80
- Cleaning the FaST System Check Valves, 81
- Cleaning the FaST System Filter Screen, 80
- Cleaning the Hopper and Debris Screen, 51
- Cleaning the Hopper Dust Filter, 75
- Contrast control button – Standard panel, 15
- Controls and Instruments, 8, 9, 10
 - Standard Touch Panel, 9, 10
- Cooling System, 71

D

- Dimensions, 96
- Directional pedal, 30
- Disabling / Enabling the Pre–Operation Checklist, 109
- Disabling the Login, 106
- Disengaging Hopper Support Pin, 49
- Double Scrubbing, 44
- Draining and Cleaning the Recovery Tank, 52
 - Draining the Recovery Tank with the Drain Hose, 52
 - Draining the Recovery Tank with the Drain Plug, 53
- Draining and Cleaning the Solution Tank, 54
- Draining the Recovery Tank with the Drain Hose, 52
- Draining the Recovery Tank with the Drain Plug, 53
- Dust Filter, 50
 - Removing the Hopper Dust Filter, 50
 - Replacing the Hopper Dust Filter, 50

E

ec–H2O module flush switch, 82
ec–H2O button – Pro–Panel, 38
Zone control buttons – Pro–Panel, 22
ec–H2O button – Standard panel, 38
Emptying the Hopper, 48
Enabling the Login, 105
Engaging Hopper Support Pin, 49
Engine, 71
 Air Filter, 72
 Camshaft and Balance Shaft Belts, 73
 Cooling System, 71
 Engine Belt, 73
 Fuel Filter, 72
 LPG Vaporizer, 72
 PCV System, 73
 Spark Plugs, 73
 Specifications, 97
 Timing Belt, 73
Engine Belt, 73
Engine Harness Fuses and Relays, 75
Engine Oil, 68
Engine speed button – Pro–Panel, 22
Engine Speed Button – Standard panel, 15
Entering the Supervisor Mode, 101
Entering the Supervisor Mode – First Time Use Only, 100
ES button – Pro–Panel, 39
ES button – Standard panel, 39
Exporting Checklists, 107

F

FaST button – Pro–Panel, 39
FaST button – Standard panel, 39
FaST System, 80, 81
 Cleaning the FaST Supply Hose Connector, 80
 Cleaning the FaST System Check Valves, 81
 Cleaning the FaST System Filter Screen, 80
 Replacing the FaST–PAK Carton, 80
Fault / Alert indicators – Pro–Panel, 56
Fault / Alert indicators – Standard panel, 56
Fault Indicators, 56
Faults / Alerts, 56
Filling the Solution Tank, 36
 Conventional Scrubbing Mode, 36
 ec–H2O scrubbing (ec–H2O Mode), 36

ES (Extended Scrub) Mode – Manually Filling Tanks, 37
ES (Extended Scrub) Mode with Auto–Fill, 37
Foam scrubbing (FaST Mode), 36

Filter shaker switch, 28

Filters, 50

 Cleaning the Hopper Dust Filter, 75
 Engine Air Filter, 72
 Gasoline Fuel Filter, 72
 Hydraulic Fluid Filter, 70
 LPG Fuel Filter, 72
 Removing the Hopper Dust Filter, 50
 Replacing the Hopper Dust Filter, 50

Freeze Protection (Machines with ec–H2O system), 93

Freeze Protection (Machines without ec–H2O system), 93

Front Wheel Support Bearing, 68

Front Wheel, Torque, 89

Fuel Filter

 Gasoline, 72
 LPG, 72

Fuel Indicator – Standard controls, 14

Fuses and Relays, 74

 Engine Harness Fuses and Relays, 75
 Optional, 75
 Relay Panel Fuses and Relays, 74, 75

H

Hazard Light Switch (Option), 28

Headlights, 28

Help button – Pro–Panel, 24

High Pressure Washer (Option), 60

Hopper Door Pivots, 69

Hopper Lift Arm Pivots, 69

Hopper Support Pin, 49

 Disengaging Hopper Support Pin, 49
 Engaging Hopper Support Pin, 49

Hour Meter – Standard controls, 14

How the Machine Works, 31

Hydraulic Fluid, 70

Hydraulic Hoses, 71

Hydraulic System, System specifications, 97

Hydraulics, 70
 Drain and refill hydraulic fluid reservoir, 70
 Hydraulic Fluid, 70
 Hydraulic Hoses, 71
 Replace the filler cap, 70
 Replace the hydraulic fluid filter, 70

I

Incline, Rated, 32
 Indicators, Fault Indicators, 56

L

Leveling the Rear Squeegee, 87
 Lift Arm Latch, 69
 Lights
 Hazard light switch (Option), 28
 Headlight switch, 28
 Operating, 28
 LPG Vaporizer, 72
 Lubrication, 68
 Engine Oil, 68
 Front Wheel Support Bearing, 68
 Hopper Door Pivots, 69
 Hopper Lift Arm Pivots, 69
 Lift Arm Latch, 69
 Rear wheel bearings, 69
 Squeegee Caster Bearings, 68
 Steering Cylinder Bearing, 68
 Torque Tubes, 69

M

Machine components, 7
 Machine Dimensions, 99
 Machine Jacking, 92
 Machine Operation, Pre-Operation Checklist, 33
 Machine Performance
 Aisle Turnaround Width, 96
 Climb and Descent Angles, 96
 Travel Speed (Maximum), 96
 Machine Specifications, 96 – 99
 Machine status button – Pro-Panel, 18
 Machine Troubleshooting, 62
 Main Brushes, 76
 Adjusting the Taper, 78
 Adjusting the Width, 78
 Checking the Main Brush Pattern, 77
 Replacing or Rotating the Main Brushes, 76
 Main Brushes, Adjusting the Taper, 78

Main Brushes, Adjusting the Width, 78
 Main Brushes, Checking the Pattern, 77
 Main Brushes, Replacing or Rotating, 76
 Maintenance, 64 – 88
 Yellow touch points, 68
 Maintenance Chart, 65

O

Operating Lights, 28
 Operating temperature, 32
 Operation, 7 – 31
 Operation of controls – All machines
 Filter shaker switch, 28
 Hazard light switch, 28
 Operating light switch, 28
 Operation of controls – Pro-Panel, 17
 1-STEP button, 19
 Brush pressure button, 40, 41
 Changing the default button, 19
 ec-H₂O button, 38
 Engine speed button, 22
 ES button, 39
 FaST button, 39
 Fault / Alert indicators, 56
 Help button, 24
 Machine status button, 18
 Pro-Check Pre-Operation checklist, 27
 Pro-ID login screen, 17
 Scrubbing main brush button, 20
 Scrubbing side brush button, 21
 Scrubbing vacuum fan / squeegee button, 21
 Solution on / off buttons, 21
 Sweeping main brush button, 20
 Sweeping side brush button, 20, 23
 Sweeping vacuum fan button, 20
 Video help button, 26
 Zone control buttons, 22
 Operation of controls – Standard controls
 Fuel Indicator, 14
 Hour Meter, 14
 Recovery tank full indicator, 14
 Operation of controls – Standard panel, 14, 28
 1-STEP button, 15
 Brush pressure button, 40
 Contrast control button, 15
 ec-H₂O button, 38
 Engine speed button, 15
 ES button, 39
 FaST button, 39
 Fault / Alert indicators, 56
 Scrubbing main brush button, 17

- Scrubbing side brush button, 16
- Scrubbing vacuum fan / squeegee button, 16
- Solution flow button, 41
- Solution on / off button, 17
- Solution tank indicator, 14
- Sweeping main brush button, 16
- Sweeping side brush button, 15
- Sweeping vacuum fan button, 16

Operator seat, 29

Optional Relays, 75

Options, 58

- Hazard light switch, 28
- High Pressure Washer, 60
- Spray Nozzle, 58
- Squeegee protectors, 30
- Vacuum Wand, 59

P

Parking brake pedal, 29

PCV System, 73

Pedals

- Brake pedal, 29
- Directional pedal, 30
- Parking brake pedal, 29

Pre–Operation Checklist, 33

Priming the ec–H2O system, 95

Pro–Check Pre–Operation checklist –
Pro–Panel, 27

Pro–ID login screen – Pro–Panel, 17

Pro–Panel Supervisor Controls, 100

- Adding / Editing Profiles, 103
- Calibrating the Touch, 106
- Changing the Rear View Camera Settings, 110
- Checklist Setup, 108
- Disabling / Enabling the Pre–Operation
Checklist, 109
- Disabling the Login, 106
- Enabling the Login, 105
- Entering the Supervisor Mode, 101
- Entering the Supervisor Mode – First Time Use
Only, 100
- Exporting Checklists, 107
- Programming the Zone Control Buttons, 110
- Setting / Changing the Date and Time, 112
- Supervisor Setting Screen / Screen Icons, 102

Programming the Zone Control Buttons, 110

Propelling Motor, 89

- Torque Shaft Nut, 89

Pushing or Towing the Machine, 90

Pushing, Towing, and Transporting the Machine,
90

- Pushing or Towing the Machine, 90
- Transporting the Machine, 90

R

Radiator, 71

- Check hoses and clamps, 71
- Clean core exterior, 71

Rated incline, 32

Rear Squeegee

- Adjusting the Rear Squeegee Blade Deflection,
87

- Leveling the Rear Squeegee, 87

Rear Squeegee Blade, Replacing (or Rotating)
the Rear Squeegee Blade, 83

Rear Squeegee, Replacing (or Rotating), 83

Rear Wheel bearings, 69

Recovery tank full indicator – Standard controls,
14

Recovery Tank Seal, 88

Relay Panel Fuses and Relays, 74, 75

Removing the Hopper Dust Filter, 50

Replacing (or Rotating) the Rear Squeegee
Blades, 83

Replacing or Adjusting the Side Brush Squeegee
Blade (S/N 003077–) (Option), 86

Replacing or Rotating the Main Brushes, 76

Replacing or Rotating the Side Squeegee
Blades, 84

Replacing the FaST–PAK Carton, 80

Replacing the Hopper Dust Filter, 50

Replacing the Side Brush (Option), 79

S

Safety

- Instructions, 3 – 5
- Labels, 5 – 7

Scrub Head Skirt, 88

Scrubbing – Pro–Panel, 43

Scrubbing – Standard panel, 42

Scrubbing main brush button – Pro–Panel, 20

Scrubbing main brush button – Standard panel,
17

Scrubbing side brush button – Pro–Panel, 21

- Scrubbing side brush button – Standard panel, 16
- Scrubbing vacuum fan / squeegee button – Pro–Panel, 21
- Scrubbing vacuum fan / squeegee button – Standard panel, 16
- Seals, 88
 - Recovery Tank Seal, 88
 - Solution Tank Seals, 88
- Seat belts, 29
- Seat, Operator, 29
- Setting / Changing the Date and Time, 112
- Setting Brush Pressure, 40, 41
- Setting ec–H2O Mode, 38
- Setting ES (Extended Scrub) Mode, 39
- Setting ES Solution Flow, 41
- Setting FaST Mode, 39
- Setting Scrub Modes, 38
 - Setting Brush Pressure, 40, 41
 - Setting ec–H2O Mode, 38
 - Setting ES (Extended Scrub) Mode, 39
 - Setting ES Solution Flow, 41
 - Setting FaST Mode, 39
 - Setting Solution Flow, 41
 - ES (Extended Scrub) Mode, 41
- Setting the Engine Speed, 15
- Side Brush (Option), 79
 - Replacing the Side Brush, 79
- Side Brush (S/N 003077–) (Option), Replacing the Side Brush Squeegee, 86
- Side Brush Squeegee (S/N 003077–) (Option), Replacing or Adjusting, 86
- Side Brush, Replacing, 79
- Side Squeegee Blades, 84
 - Replacing or Rotating the Side Squeegee Blades, 84
- Side Squeegee, Replacing or Rotating, 84
- Skirts and Seals, 88
 - Recovery Tank Seal, 88
 - Scrub Head Skirt, 88
 - Solution Tank Seals, 88
- Solution flow button – Standard panel, 41
- Solution on / off button – Standard panel, 17
- Solution on / off buttons – Pro–Panel, 21
- Solution tank indicator – Standard panel, 14
- Solution Tank Seals, 88
- Spark Plugs, 73
- Specifications, 96 – 99
 - Braking system, 97
 - ec–H2O System, 98
 - FaST System, 98
 - Hydraulic System, 97
 - Machine Capacities, 96
 - Machine Dimensions, 96
 - Machine Performance, 96
 - Power Type, 97
 - Steering, 97
 - Tires, 97
- Spray Nozzle (Option), 58
- Squeegee Blades, 83
 - Replacing (or Rotating) the Rear Squeegee Blades, 83
 - Replacing or Rotating the Side Squeegee Blades, 84
- Squeegee Caster Bearings, 68
- Squeegee Protectors (Option), 30
- Standard Touch Panel, 9, 10
- Starting the Machine, 35
- Steering, Specifications, 97
- Steering Cylinder Bearing, 68
- Storage Information, 92
 - Freeze Protection, 93
 - Priming the ec–H2O system, 95
 - Storing the Machine, 92
- Supervisor Controls, 100 – 124
- Supervisor Setting Screen / Screen Icons, 102
- Sweeping – Pro–Panel, 47
- Sweeping – Standard panel, 46
- Sweeping main brush button – Standard panel, 16
- Sweeping main brush button – Pro–Panel, 20
- Sweeping side brush button – Pro–Panel, 20, 23
- Sweeping side brush button – Standard panel, 15
- Sweeping vacuum fan button – Pro–Panel, 20
- Sweeping vacuum fan button – Standard panel, 16
- Symbol definitions, 11 – 13

T

Temperature, Operating, 32
Thermo—Sentry, 76
Timing Belt, 73
Tires, 89
 Specifications, 97
Torque Tubes, 69
Touch points, yellow, 68
Towing the Machine, 90
Transporting the Machine, 90
Turning Off the Machine, 35

V

Vacuum Wand (Option), 59
Vaporizer, 72
Video help button – Pro—Panel, 26

W

Warning Indicators, 56
 Fault Indicators, 56
Water Pickup Mode (No Scrubbing), 45
Wheels, 89
While Operating the Machine, 32